



Standard
Club

By your side

A Master's Guide to:

Container securing

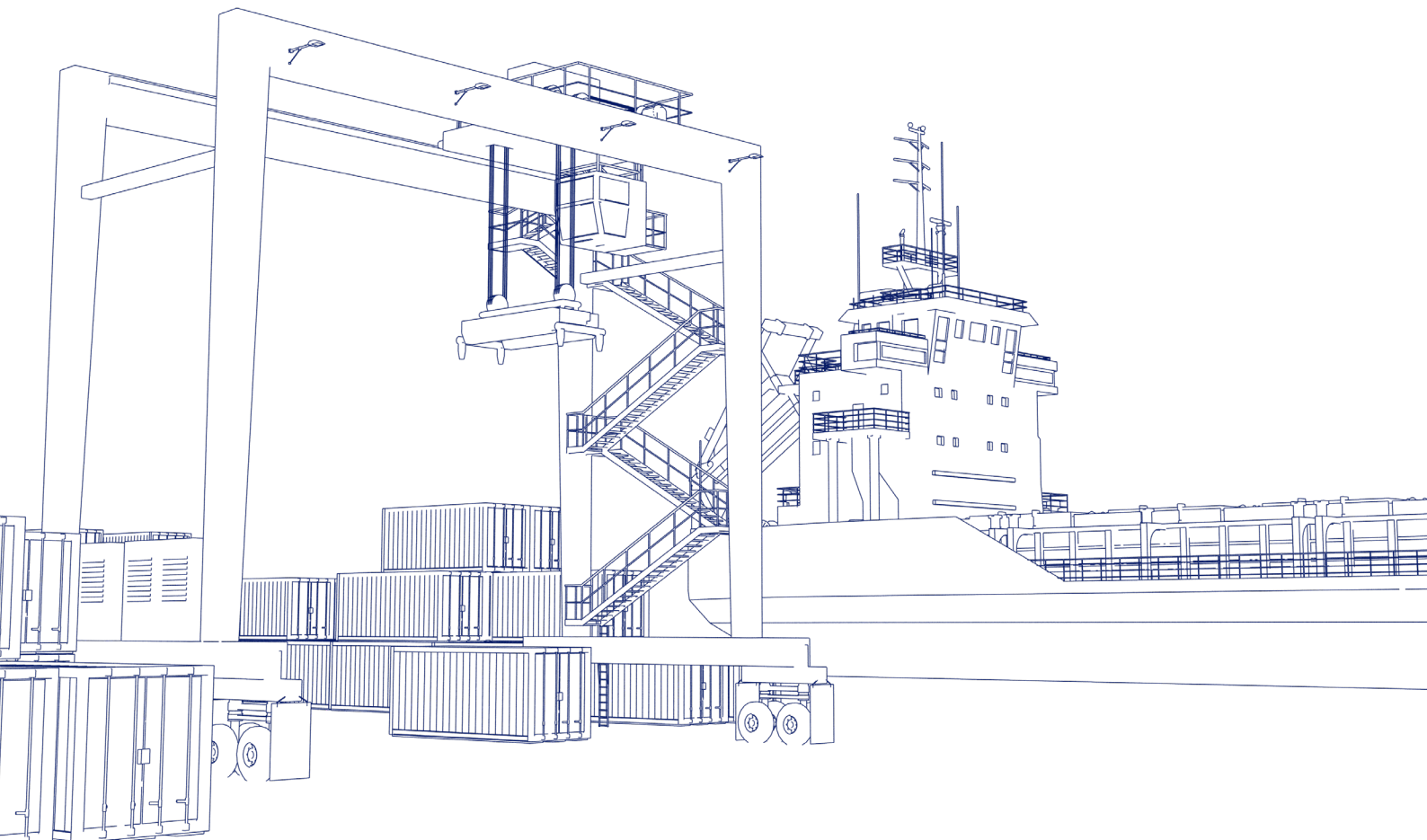

About this Guide

The purpose of this guide is to discuss container securing systems, the causes of lashing failure and to offer advice as to how losses can be minimised.

As part of the Loss Prevention department's continuing commitment to safety at sea, a number of 'Master's Guides' have been produced. They focus on delivering best practice advice on key areas of vessel operations to avert avoidable claims and prevent accidents, casualties and incidents at sea. These guides were created by harnessing the professional knowledge of members in the Loss Prevention team who have served at sea.

The guide to Container Securing is an original Standard Club document first produced in 2006. Now in its third edition, this guide revises the advice on applying extra lashings to realign the publication with current standards and includes additional advice on design roll angle and the container securing arrangement, periodic checks of lashings, and avoidance of overtightening lashings. This guide sets out to promote industry best practice and was written in collaboration with Lloyd's Register, one of the world's leading providers of professional services for engineering and technology.

Captain Yves Vandeborn, Director of Loss Prevention

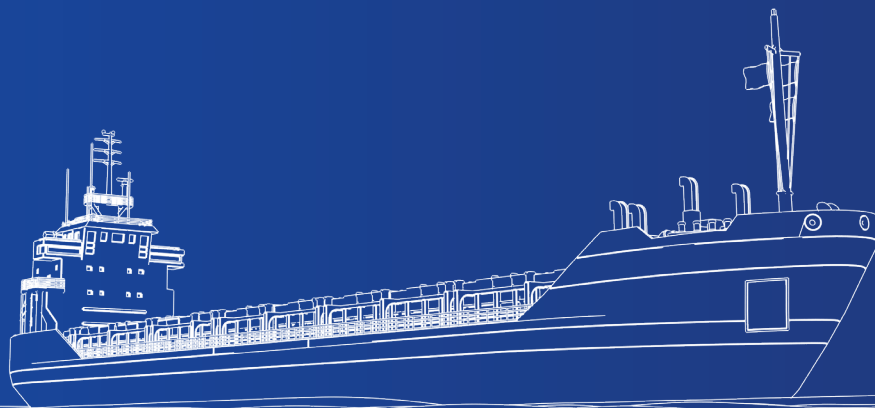

Contents

01. Introduction	4		
02. Basic advice	6		
Points to remember:	6		
03. Dos and don'ts	8		
Always:	8		
Never:	9		
04. Lashing systems – common false beliefs	10		
05. Safe working	12		
Working with containers	12		
Lashing areas	13		
Working areas must:	13		
06. Ships	14		
Ship types	14		
Ship classification	15		
07. Containers	16		
Container sizes	16		
Container types	18		
Dry van boxes	18		
Curtain wall containers	18		
Refrigerated containers	18		
Tank containers	18		
Flat-rack containers	19		
Euro containers	19		
08. Container construction	20		
Construction and strength	20		
Corner posts	20		
The outer frame	20		
Corner castings	20		
Forklift pockets	20		
Container certification	20		
Certification	21		
		Container construction	22
		ISO Series 1 freight containers	22
		International Convention for Safe Containers (CSC)	22
		Certification of reefer containers	23
		Containers with open doors	23
		09. Lashing components	24
		Fixed fitting (attached to ship)	24
		Loose fittings in common use	25
		Loose fittings in less common use	27
		Lashing components	28
		10. Principles of stowage	30
		Containers carried below deck in cell guides	32
		Containers carried below deck without cell guides	34
		Containers carried on deck	34
		When stowing and securing containers, the following points should be borne in mind:	37
		Checks and tests during discharge and loading	38
		Checks and tests at sea	38
		Very large container ships	38
		11. Ship behaviour	40
		Ship's structure	40
		Container strength and ship motion	40
		Parametric rolling	42
		Why are large container ships vulnerable?	42
		Consequences of a parametric roll	42
		Very large container ships	43
		12. Consequences of failure – case study	44
		Course and speed	45
		Stowage and securing	45
		List of photos and diagrams	48
		Authors	50

01. Introduction

The development of containerisation was a giant step forward in carrying general cargo by sea. At the time, it was correctly predicted that unit costs would fall, and cargo damage would become a thing of the past.

In the early days of containerised transport, ships carried containers stowed on hatch covers, three or four high. A variety of lashing systems were in use. However, the most reliable system consisted of stacking cones, twistlocks, lashing rods and turnbuckles (bottle screws). These systems were effective in lashing containers carried on deck to the third tier.

Today, ships are bigger, and a new-Panamax container ship will carry containers on deck stacked up to 12 tiers high. However, while ships can carry containers stacked higher, the lashing systems have not changed significantly with the use of manual, semi-auto and fully auto twistlocks. Turnbuckles and lashing bars are still only capable of lashing to the bottom of the third tier containers or slightly higher up the stack when a

lashing bridge is fitted. Ship design has developed, but methods to secure containers have not significantly moved on and the forces experienced in the stack are generally not fully appreciated or understood by those operating the ship.

A classification society will approve a ship for the carriage of containers. Regulations stipulate that the ship must carry a Cargo Securing Manual. This manual will contain instructions as to how cargo should be secured in accordance with class criteria and a specified metacentric height (GM). For the approval of the arrangements in the manual, it is still expected of the master to apply good seamanship in order to mitigate excessive ship motions to reduce forces acting on the cargo stowage arrangements.

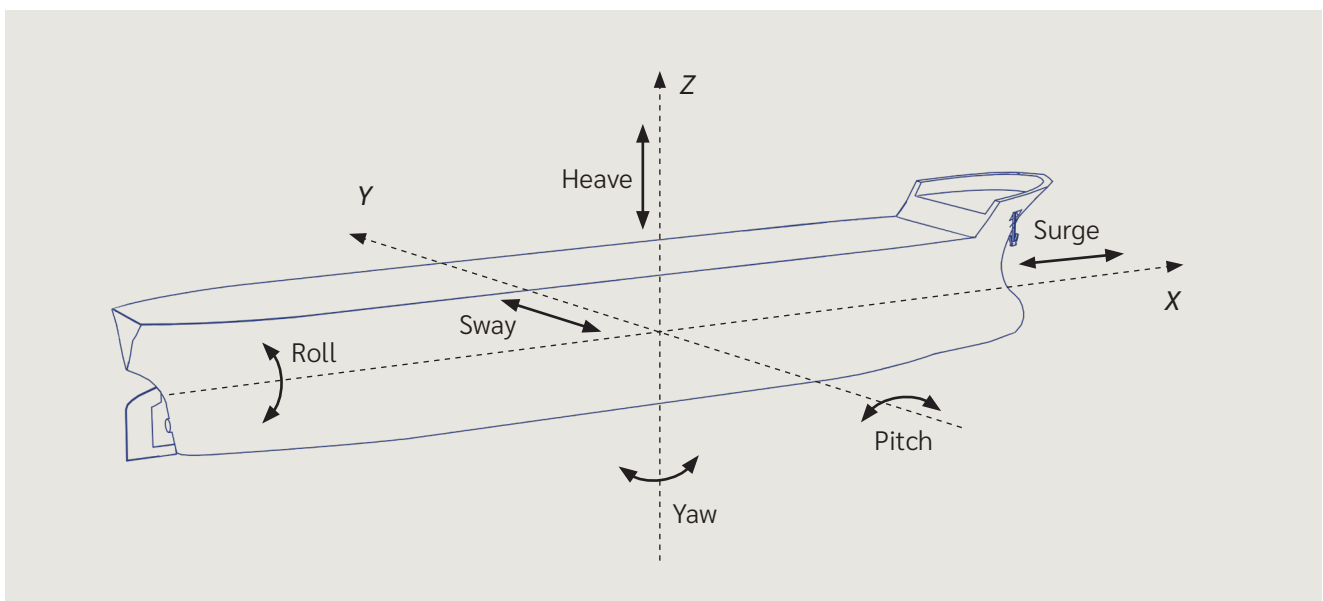

Figure 1: Six degrees of ship's motion

A ship sailing in a seaway has six degrees of motion: surge, sway, heave, roll, pitch and yaw. The ship itself bends and twists as waves pass. Hatch covers move relative to the hatch openings and container stacks move as clearances in the lashing equipment are taken up. It is the lashing system alone that resists these movements and attempts to keep the containers on board.

When we think about the forces acting on a container, we need to be aware that as the ship moves in a seaway the forces become accelerative and will increase and decrease as the ship moves. These ship movements are caused by the pitching, rolling, heaving, surging, yawing and swaying of the ship. The accelerative forces are said to be dynamic and not only act on the containers but also act on the ship. These dynamic forces can sometimes be quite considerable.

The container securing arrangement is designed around criteria, taking into consideration these dynamic forces, and the effects of racking, tipping and corner-post compression on the container. However, if these dynamic forces exceed the design criteria then a failure in the lashing system may occur, risking a container stack collapse which in turn may give rise to stack interaction. It is the stack interaction which enables the resultant forces to intensify and cause the collapse of numerous container stacks within the bay or the loss of containers from the deck. Masters should be aware that altering the ship's speed and heading will reduce excessive dynamic forces.

Lashing systems are put to the test during bad weather, due to the increase in accelerative forces experienced with the movement of the ship. Indeed, the growing number of containers lost overboard has caused concern throughout the marine industry, and for the public also, especially where the retrieval of containers carrying hazardous substances is

concerned. Cargo claims have increased, and floating, partially submerged and sunken containers pose a hazard to navigation. Masters need to understand the strengths and weaknesses of container securing systems, including the direct relationship that accelerative forces have with the GM, speed and movement of the ship. Masters must be aware of what can be done to prevent container loss.

Ships need to be fit to receive containers, with their lashing equipment in good order. Lashing areas need to be safe places for ships' crews and stevedores to work.

The purpose of this guide is to discuss container securing systems, the causes of lashing failure and to offer advice as to how losses can be minimised.



Figure 2: Ship alongside discharging containers

02. Basic advice

There are certain actions that should always be taken to prevent containers from being damaged or lost overboard. The following steps are considered best practice.

Points to remember:

- Check stack weights before stowage. It is important not to exceed the allowable stack weights; otherwise, failure of the deck container foundation of the stack is possible. If the stow is too heavy, the lashings may have insufficient strength to hold the containers in place if bad weather is encountered.
- Consult the Cargo Securing Manual and adhere to the approved lashing arrangement.
- Review carefully the container securing software input data and its warning messages.
- Discuss the proposed loading with the stevedores to ensure that the proposed loading does not compromise the ship's lashing system, loading requirements or stability.
- Consult the Cargo Securing Manual before applying lashings.
- Try to avoid isolated stacks of 20ft containers within 40ft bays in the hold.
- Avoid loading heavy containers above light containers and at the top of a stack. If this stowage is unavoidable, then ensure that it is found satisfactory when checked using the approved loading computer.
- Give the shore lashing gang precise instructions as to how containers should be secured.
- If the ship is certified for the carriage of dangerous goods, reference should be made to the IMDG Code for information on the classes of dangerous goods to be loaded, their handling, stowage, securing and carriage.
- Examine containers for physical defects – check the corner posts carefully. The corner posts must resist high compression forces as a result of static weights from containers stowed on top and from dynamic forces that occur when the ship rolls, heaves and pitches.
- Reject damaged containers. Containers with damaged corner posts placed in the bottom of a stow are likely to collapse.
- Check that all cell guides are clear of obstacles, are straight and are not buckled.
- Periodically check that turnbuckles are fully tightened in accordance with the Cargo Securing Manual, especially prior to and after adverse weather. Loose lashings will be ineffective and over-tightened lashings may overload the stow.
- Avoid using left-hand and right-hand twistlocks on the same ship.
- Regularly examine lashing components, including ship fittings, for wear and defects. Replace worn or damaged lashing components. Repair worn or damaged ship fittings. Check all equipment, not just equipment in regular use. Keep turnbuckles and twistlocks clean and well-greased
- If in doubt, replace equipment. It is difficult to know when lashing components should be replaced. Few organisations are confident to issue 'criteria for replacement', which means that the ship's owner or individual Master will need to exercise judgement. Give special attention to dovetail or sliding socket foundations. As fittings are permanently in use, schedule batch replacements periodically to minimise operational impact.

- Remember that during ship rolling, forces on container corner posts can be up to three times greater than the upright compression force. Weather route to avoid the worst of the meteorological systems or areas where high seas in winter are common. Check with the loading computer or software provided. If navigating in bad weather, reduce speed, avoid beam seas and proceed with caution until the storm has passed.
- Be aware of the phenomenon of parametric rolling and how changes in speed and/or course can separate pitching and rolling frequencies.
- Before loading, identify where 'high cube' containers are to be stowed. The approved container securing arrangement (CSA) will show if these containers can be loaded on deck in the first or second tier. Lashing rods are more difficult to fit and special rods with extension pieces are often needed. It may be necessary to reposition them.
- Always consider personal safety when accessing lashing positions and working with lashing equipment. This applies equally in port and at sea.

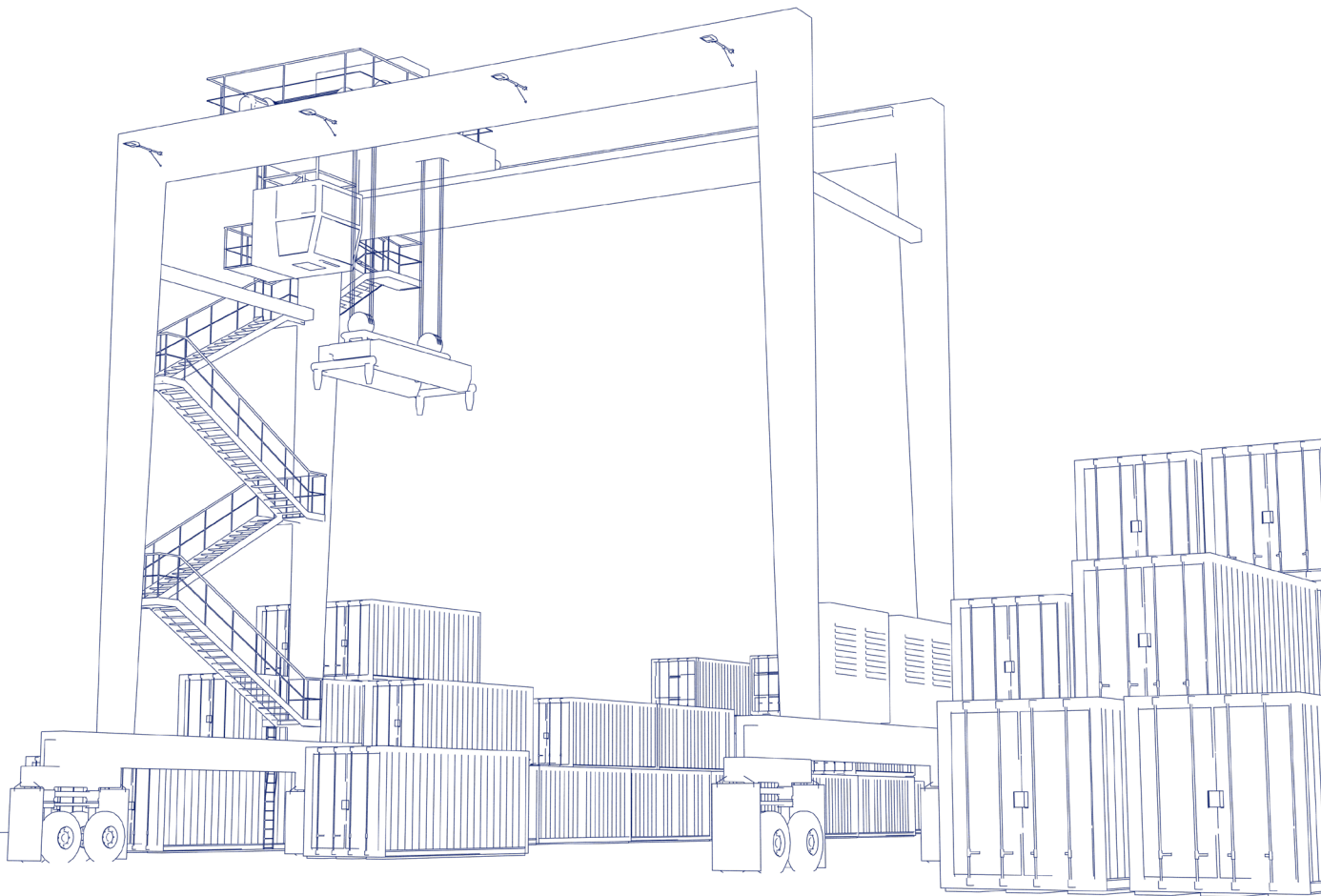

03. Dos and don'ts



Always:

- Reject a container that exceeds the declared weight or is likely to give rise to the permissible stack limits being exceeded.
- Reject a buckled, twisted or damaged container.
- Check that containers have a valid CSC plate.
- Arrange stowage so that containers do not need to be unloaded at a port other than the designated discharge port.
- Regularly check lashing components for condition and discard components that appear worn or are damaged.
- Regularly check container corner castings for wear at the twistlock and lashing rod securing points. This is especially important when fully automatic twistlocks are used.
- Inspect D rings, ring bolts, cell guides and sliding socket foundations for wear or damage before containers are loaded, and arrange for the necessary repairs.
- Regularly check and tighten lashings during the voyage, when safe to do so.
- Turnbuckle locking nuts should be fully tightened.
- Inspect and tighten lashings before the onset of bad weather. Pay particular attention to the forward and aft areas, and where vibration could cause turnbuckles to loosen.
- Take care when handling container fittings, as they are heavy. Avoid dropping them.
- Stow loose lashing components, twistlocks and lashing rods safely in designated baskets or racks.
- Buy components that are supported by a test certificate. The strength of equipment without a test certificate may be unpredictable and therefore it is unacceptable for use. Keep a copy of the test certificate on board.
- All container lashing equipment must be approved and listed in the Cargo Securing Manual.
- Have more securing equipment than necessary.
- Avoid extreme values of GM, whether high or low, wherever possible.
- Avoid stowing 'high cube' containers in outboard positions, unless permitted by the container securing arrangement (CSA).
- Avoid conditions for parametric rolling to exist.
- Look for indications of water leakage into the container and for indications of leakage from the container, use safety equipment.
- Fit removable fencing before accessing lashing positions.
- Close gratings and covers after passing through.
- Report faulty equipment, including damaged ladders, fencing, lighting or safety rails.
- Report problematic work arrangements and discuss lashing safety during safety committee meetings. Feedback can help to make ships safer.
- Make sure container doors are closed.



Never:

- Mix left-hand and right-hand twistlocks.
- Apply fully automatic twistlocks without first checking the manufacturer's instructions for use and the requirements in the ship's Cargo Securing Manual.
- Use corroded or buckled lashing rods.
- Use twistlocks that are not certified.
- Use corroded or damaged twistlocks.
- Use improvised equipment to secure containers.
- Load containers of a non-standard length or width except when the ship is designed and equipped for the carriage of these non-standard containers.
- Overtighten lashing rods. This can occur when lashing rods are tightened during ship rolling because one side of crossed lashings will be less tight on the heeled side. Tightening on a roll can cause overtightening. Lashing rods can also be overtightened when a very long metal bar is used to tighten the turnbuckle.
- Use twistlocks for lifting containers except where the twistlocks are specifically approved for this purpose.
- Open containers after they have been loaded. Closed doors are a component of the container's strength.
- Connect reefer containers to damaged or broken electrical sockets.
- Load containers in a con-bulker that requires fitting a buttress, unless the buttress is already fitted.
- Lash to the top of a container. Always lash to the bottom of the next tier wherever possible, unless stated otherwise in the CSA.
- Use a fully automatic twistlock to secure containers when the container's bottom is exposed and it could be lifted by green seas.
- Apply lashings to the overhanging end of a 45ft container when the container is stowed over a 40ft container. 45ft containers are usually stowed aft of the ship's accommodation and above the position where lashing rods are applied. They are therefore held in position with twistlocks.
- Stand or walk below containers that are being lifted. Twistlocks or other debris can sometimes fall.
- Work dangerously with containers. Never stand or climb onto them, or under or between them.
- Drop or throw fittings, especially twistlocks, from a great height onto a steel deck or other hard surfaces.
- Use a mixture of fully automatic, semi-automatic and manual twistlocks in the same tier.
- Remove the hatch cover stoppers before hatch cover stowed containers have been discharged.
- Stand adjacent to container stacks that are being loaded or unloaded, as the container may swing and hit you.

04. Lashing systems – common false beliefs

P&I club investigations into container losses indicate that a loss often occurs because an apparent weakness has not been identified. The following common false beliefs or assumptions are worth noting:

- **Once containers have been loaded and secured, the stow remains in a tight block and does not move – False**
Twistlock and sliding socket clearances will allow containers to move before the twistlocks engage. The clearance will permit movement of the stow. Wear inside the corner fitting can cause additional movement.
- **Containers can be stowed in any order and/or combination/mix of weights – False**
The most common mistake made when stowing and lashing containers is to load heavy containers over light or to load so that the maximum permissible forces in the stack are exceeded. Heavy on light can only be accepted when specifically permitted by the loading computer or provided software.
- **Lashings applied from a lashing bridge behave in the same manner as those applied at the base of a stow – False**
A lashing bridge is a fixed structure, while a hatch cover will move when a ship rolls and pitches. The resulting effect could be that a lashing from a lashing bridge becomes slack or takes an excessive load.
- **Containers loaded on a pedestal and a hatch cover do not suffer additional loading – False**
A hatch cover is designed to move as the ship bends and flexes. A container stowed on a pedestal, which is a fixed point, will attempt to resist hatch cover movement if also secured to a hatch cover.
- **Lashing rods should be tightened as tight as possible – False**
In theory, excessive tightening of lashing rods will result in the rods taking additional strain, which can cause corner casting failure when under load and excessive forces on the stack.
- **It is not necessary to adjust the tension in lashings while at sea – False**
Movement of containers will result in some lashing rods becoming slack. Air temperature differences will cause tension in the lashings to change. Lashings should be checked and tightened within 24 hours after leaving port and regularly thereafter. This is especially true before the onset of bad weather.
- **Container strength is equal throughout the container – False**
Even if strength standards are met, a container is more flexible at the door end and may be more vulnerable in this area.
- **All twistlocks can be used to lift containers – False**
Twistlocks can be used for lifting containers only when they have been approved and certified for that purpose.

- **Twistlocks are all rated to the same strength – False**

Twistlocks can be rated for different tensile loads up to 20 or 25 tonnes. It is important not to use a mix of twistlocks that have different strength ratings.

- **All containers have the same strength – False**

Container strength can vary. There are two ISO standards (pre-and post-1990). Some containers can be worn or damaged.

- **Horizontal lashings from lashing bridges are an alternative to vertical cross lashings – False**

Crossed horizontal lashings from lashing bridges will hold a container. However, the container will be held rigidly to the fixed lashing bridge. When a ship bends and twists, the base of a container attached to a hatch cover will move, but container ends held firmly to a lashing bridge with horizontal lashings will not move. The effect will be to put a strain on the lashings and even break the bars or damage the container corner castings.

Horizontal lashings should not be used unless specifically permitted by the approved lashing plans shown in the Cargo Securing Manual.

- **Parametric rolling will not occur on ships with a high GM – False**

Parametric rolling occurs because of the fine hull form of large post-Panamax container ships. The large bow flare and wide transom increase the effect. The phenomenon occurs because of changes in the waterplane area, which can cause large changes in GM as waves pass. A large initial GM will provide large righting levers that can lead to violent rolling.

- **Provided stack weights have not been exceeded, the distribution of containers in a stack on deck is not important – False**

The stack weight distribution impacts the internal forces in the lashing rods and containers. The container securing arrangement (CSA) or lashing software should be followed. This is because the securing system would normally have been designed on the assumption that light containers are stowed on top. Stowage may allow for 'heavy-heavy-light'. However, loading 'heavy-medium-medium' may result in the same stack weight but would produce different strain on the securing system, especially if the GM is high.

- **Containers need not be stowed in block stowage – False**

Generally, container stacks do not depend on each other for support. However, they do provide protection to each other from wind and waves, so stowage in isolated stacks, especially in outboard locations, should be avoided.

05. Safe working

Working with containers

The decks, hatch covers, lashing bridges and holds of a container ship can be hazardous places to work. To avoid accidental injury, exercise care and follow these rules:

- When working on deck, always wear high visibility clothing, safety shoes and a hard hat.
- Always install temporary fencing and safety bars before starting cargo operations.
- Never allow fittings to be thrown onto the ship's deck from a height.
- Check that sliding sockets and stacking cones are removed from hatch covers before opening.
- When working in the vicinity of moving containers, never work with your back towards a container or stand where a swinging container could strike you.
- Never stand or walk under a raised container.
- Never place your hand or clothing under a container that is being lowered.
- When working on the top or side of a container, use safe access equipment and never climb containers.
- If working from a portable ladder, make sure the ladder is properly secured and has non-slip feet so that metal-to-metal contact is avoided. Wear a safety harness, a hard hat and high visibility clothing. Attach the line from the harness to a secure point and arrange for a member of the ship's crew to stand by to assist.
- Take care when climbing onto a lashing bridge. There could be loose items of equipment that could fall, or the safety bar could be across the opening.
- Tidy loose equipment that is lying on decks, hatch covers, lashing bridges and coamings, as these are trip hazards.
- Never climb up a stack of containers. Use an access cradle.
- Take care when fixing penguin hooks or lashing rods, as these can slip and strike someone.
- Avoid excessive stretching, bending or leaning when placing lashing rods. Their weight can be deceptive.
- Close access gratings after passing through. They are there to protect you.

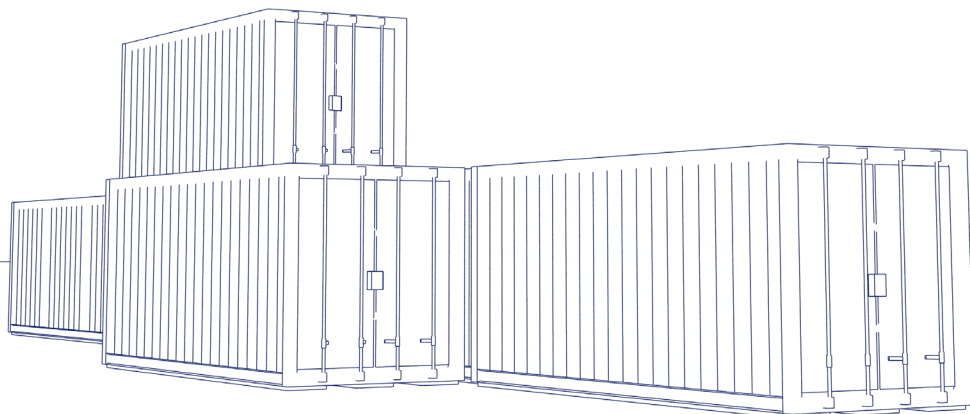

Lashing areas

Ships should be arranged to enable safe application and inspection of container lashings. Work areas should be of adequate dimensions, free from trip hazards, provided with fall protection and with adequate lighting. Transit areas should be free from obstructions and trip hazards. They should have adequate headroom, lighting and non-slip walkways.

The main working positions are between stacks, on lashing bridges, outboard locations and on hatch cover ends. A risk assessment of working positions should be arranged to identify hazards and to enable corrective action. When completing these assessments, the following requirements for safety during the application of lashings should be considered.



Figure 3: Application of outboard lashings

Working areas must:

- Avoid the necessity for container-top working.
- Be designed with the work platform and lashing plate on the same level.
- Be of adequate size.
- Be arranged to avoid excessive stretching or bending during lashing application.
- Have outboard areas and potential falls fitted with permanent or, where that is not possible, temporary fencing.
- Have adequate lighting and non-slip surfaces.
- Have safe arrangements for stowage of spare equipment.
- Have access hatch openings to raised working areas closed by gratings rather than solid covers.



Figure 4: Crew member clearing lashing equipment from work area

Work areas at heights of 2m or more need to be fitted with fall protection in the form of fencing. Fencing should have its top rail at least 1m high and an intermediate rail should be fitted at a height of 0.5m. Toe boards should be fitted where people below could be exposed to falling objects.

Work and walkways, whether above or below the deck or on a bridge, require lighting. In work areas, the level of lighting should be sufficient to enable the inspection of containers, both in port and at sea, to detect damage and leakage, and to read markings or labels.

06. Ships

A ship is only designated as a container ship if it is designed exclusively for the carriage of containers.

Ship types

Container ships – cellular

- Designed exclusively for the carriage of containers
- Containers in holds are secured by cell guides
- Containers on deck are secured by portable lashing components, often rods and twistlocks



Figure 5: Cellular container ship

Container ships – hatchless

- Designed exclusively for the carriage of containers
- No hatch covers
- The bridge may be located fully forward to provide protection
- If the bridge is not sited forward, it is common for the forward two or three holds to be fitted with hatch covers, especially if dangerous goods are to be carried
- All containers are secured in cell guides



Figure 6: Hatchless container ship

Con-bulkers

- Hold arrangements suitable for the carriage of both containers and bulk cargoes
- Various configurations, including:
 - bulk cargoes carried in designated holds, containers in other holds
 - containers carried above a bulk cargo
 - containers carried only on deck



Figure 7: Typical arrangement for con-bulker with gantry crane

Ro-Ro ships

- Suitable for the carriage of [both containers and roll-on/roll-off transport]
- Various configurations, including:
 - Ro-Ro cargo aft and containers in conventional holds forward
 - containers loaded by forklift trucks on Ro-Ro decks
 - containers on deck and Ro-Ro cargo on the Ro-Ro decks



Figure 8: Ro-Ro cargo ship with containers on deck

General cargo ships

- Containers in holds, generally secured by buttresses and bridge fittings
- Containers on deck secured by container securing equipment
- Containers may be carried athwartships. Only possible when cargo is carefully stowed within the container
- Containers loaded on dunnage and carried as general cargo



Figure 9: Multipurpose general cargo ship with the capacity to carry containers on deck

Ship classification

The ship classification process ensures that the ship's hull, hatch covers, lashing bridges, cell guides and fixed fittings have enough strength. Although a classification society will assess the adequacy of loose fittings and assign a class notation, this examination is additional to the mandatory ship classification process.

Multi-purpose ships may carry containers and general cargo. These ships can be cellular container ships with a stiffened tank top with the ability to 'stopper' (block) cell guides.

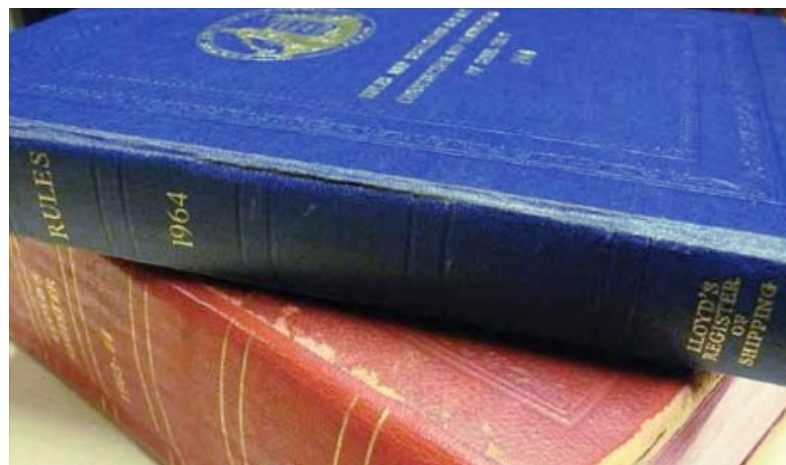

Figure 10: Lloyd's Register of Ships and Rules & Regulations for the Classification of Ships.

07. Containers

Most containers carried at sea are designed and approved to ISO standard and are regularly inspected in accordance with the International Convention for Safe Containers (CSC) for damage, to ensure that they continue to be suitable for the very large loads which they are required to bear while at sea. There are various types, sizes and designs of container. Not all are suitable to be part of a container stow.

Container sizes

Containers are standardised cargo units. They are normally manufactured to the sizes specified in ISO 668, but they can be manufactured in a variety of sizes and types, each designed to meet specific cargo and transportation requirements. Their length is usually 20ft or 40ft, although longer containers are used, principally in the US trade. These containers are 45ft or 48ft long. Their width is standardised at 8ft (2,438mm), although their height can vary. The term ‘high cube’ container usually refers to a standard-sized container that has a height of 9ft6in. Container heights can be 8ft, 8ft6in or 9ft 6in.

Containers are referred to by the acronyms TEUs, which stands for 20ft equivalent units, or FEUs, which stands for 40ft equivalent units.

The ISO standard for containers (ISO 668) defines dimensions, both internal and external, and load ratings. All containers have a framework and corner posts fitted with corner castings. The castings at each corner of the container support the container’s weight.

The castings are the only points at which a container should be supported and are used to attach securing fittings, such as lashing rods and twistlocks. The position and spacing of corner castings are carefully controlled.

Containers with stacking limitations (such as a five-high stack) have labels marking these requirements. The stacking capability is also specified on the CSC plate.

The usual value for allowable stacking is 192,000kg, which is a nine-high stack of containers, calculated as eight containers stacked above, each with a mass of

24,000kg (8 x 24,000 = 192,000). This calculation is associated with a vertical acceleration of 1.8g. A greater stack may be allowed if the acceleration is less than 1.8g.

ISO 1496-1, specifies the basic specifications and testing requirements for ISO Series 1 freight containers.

ISO 1496-1 updated the corner post strength test in amendment 4, from 848kN to 942kN. However, as this information is not included in the stowage information (BAPLIE file), it is difficult to confirm whether the container at the bottom of the stack is the weaker ISO 1496 Amendment 1-3 container.

Containers that are longer than 40ft usually have additional support points at the 40ft position so that they can be stowed over a standard 40ft container. Standard sizes for ISO Series 1 freight containers include those shown in the table below.

Twenty-foot containers are a little shorter than 20ft, so that two 20ft containers can be stowed in a 40ft bay. The actual dimensions are 12,192mm for a 40ft container and 6,058mm for a 20ft container. Thus, two 20ft containers are 76mm shorter than a 40ft container. This clearance is often referred to as the ‘ISO gap’.



Figure 11: CSC plate



Figure 12: Do not lash to the overhanging end of a 45ft container

ISO Series 1 freight containers have a uniform width of 2438 mm (8 ft). The nominal lengths are listed in the table below.

Containers 2896 mm (9 ft 6 in) in height are designated 1EEE, 1AAA and 1BBB. Containers 2591 mm (8 ft 6 in) in height are designated 1EE, 1AA, 1BB and 1CC. Containers 2438 mm (8 ft) in height are designated 1A, 1B, 1C and 1D. Containers less than 2438 mm (8 ft) in height are designated 1AX, 1BX, 1CX and 1DX. The letter “X” used in the designation has no specific connotation other than to indicate that the height of the container is between 0 and 2438 mm (8 ft).

Designation	Length		Width		Height	
	mm	ft / in	mm	ft / in	mm	ft / in
1EE	13716	45'	2438	8'	2896	9' 6"
1EE					2591	8' 6"
1AAA	12192	40'	2438	8'	2896	9' 6"
1AA					2591	8' 6"
1A					2438	8'
1AX					<2438	<8'
1BBB	9125	29' 11 ¼"	2438	8'	2896	9' 6"
1BB					2591	8' 6"
1B					2438	8'
1BX					<2438	<8'
1CC	6058	19' 10 ½"	2438	8'	2591	8' 6"
1C					2438	8'
1CX					<2438	<8'
1D	2991	9' 9 ¾"	2438	8'	2438	8'
1DX					<2438	<8'

Containers continued

Container types

There are several types of containers in common use. They all have the same frame, and the differences relate to what they can be used for and access.

Dry van boxes

- These are the most common type.
- They have corrugated steel walls, a timber base and a steel or glass reinforced plastic (GRP) top.
- Their walls can be made from plate of as little as 1.6mm (1/16in) in thickness.
- Their frame consists of side and end rails, and corner pillars with corner castings.
- The closed end is approximately 4.5 times stiffer, in racking strength, than the door end.
- The closed ends are a component of their strength.

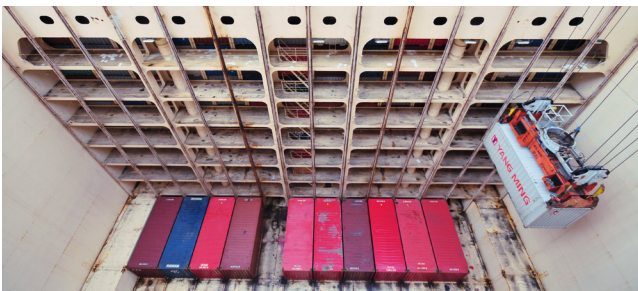

Figure 13: 40ft dry van box containers

Curtain wall containers

- Curtain wall containers are similar to dry van boxes, but have fabric side walls that can be opened to facilitate easy cargo handling.

Refrigerated containers

- Their general construction is the same as for dry van boxes.
- They usually have their own refrigeration unit, with an air or water-cooled heat exchanger.
- A small number of CONAIR boxes use close-coupled ventilation.
- They have their own data logger to record temperature.
- Some have controlled atmosphere for the carriage of fruit.



Figure 14: Reefer unit

Tank containers

- These have a steel skeletal framework within which the tank is housed.
- The steel framework must have equivalent strength to a dry van box.
- The tank has its own design and strength criteria, and it may be a pressure vessel.
- If carrying 'dangerous goods', the tank container will also be certified to ADR/RID/IMDG.



Figure 15: Typical arrangement for a tank container

Euro containers

- Euro containers are 45ft containers designed to comply with EU Directive 96/53.
- They have shaped corner castings to comply with road transportation regulations.
- Their cell guides need to be appropriately designed to ensure that the containers cannot slip out of them.

Flat-rack containers

- The container frame can be folded flat for ease of transportation when empty.
- The structure must have equivalent strength to a dry van box.



Figure 16: Two flat racks



Figure 17: Corner casting arrangement for a Euro container

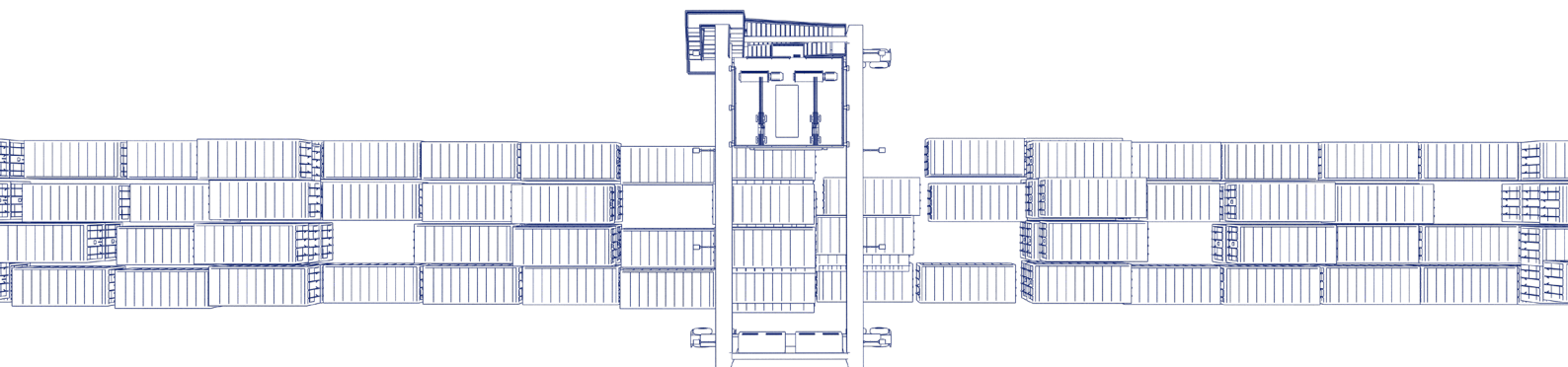

08. Container construction

Construction and strength

The strength of a container is provided principally by the outer framework, side rails and corner posts, together with the corner castings. The side, end panels and closed doors provide racking strength.



Figure 18: Container test rig

Corner posts

Effective stacking of containers relies on the strength of the corner posts to support the weight of the containers above. Damage to a corner post, in particular buckling, can seriously degrade its compressive strength and lead to the collapse of a container stack.

A series of tests are undertaken on a prototype container to comply with the Lloyd's Register Container Certification Scheme (LR-CCS), the CSC and the applicable ISO standards.

These tests simulate the different loads the container is likely to be subjected to. The photo above shows a stacking test.

The outer frame

Horizontal forces on the container, such as those caused by roll and pitch motions, are resisted by the

racking strength of the container. This is provided by the frame and also by the plate walls. Of course, soft-walled containers rely totally on the racking strength of the frame.

Corner castings

A container's corner castings take the twistlocks or stacking cones, which are used to connect containers to each other or to the ship's deck/hold, and the lashing rods, which are used to secure and support the stow. During lifting, the crane's spreader bar connects to the corner castings.

While compressive loads can be carried by the direct contact between the containers, tensile and shear loads are resisted by the loose fittings. It is important that the corner castings are in good condition if the fittings are to work effectively and perform their intended function.

The position of corner fittings must be carefully controlled during the manufacture of containers to ensure that they fit together properly and to ensure that the fittings work effectively.

Forklift pockets

These can be cut into the bottom side rail and are used when the containers are lifted by a forklift trucks. Forklift pockets are a discontinuity in the side rail that could weaken the container if contact damage occurs.

Container certification

New designs of a container are prototype tested to ensure that they have sufficient strength. If tests prove satisfactory, the container design may be certified by a classification society.

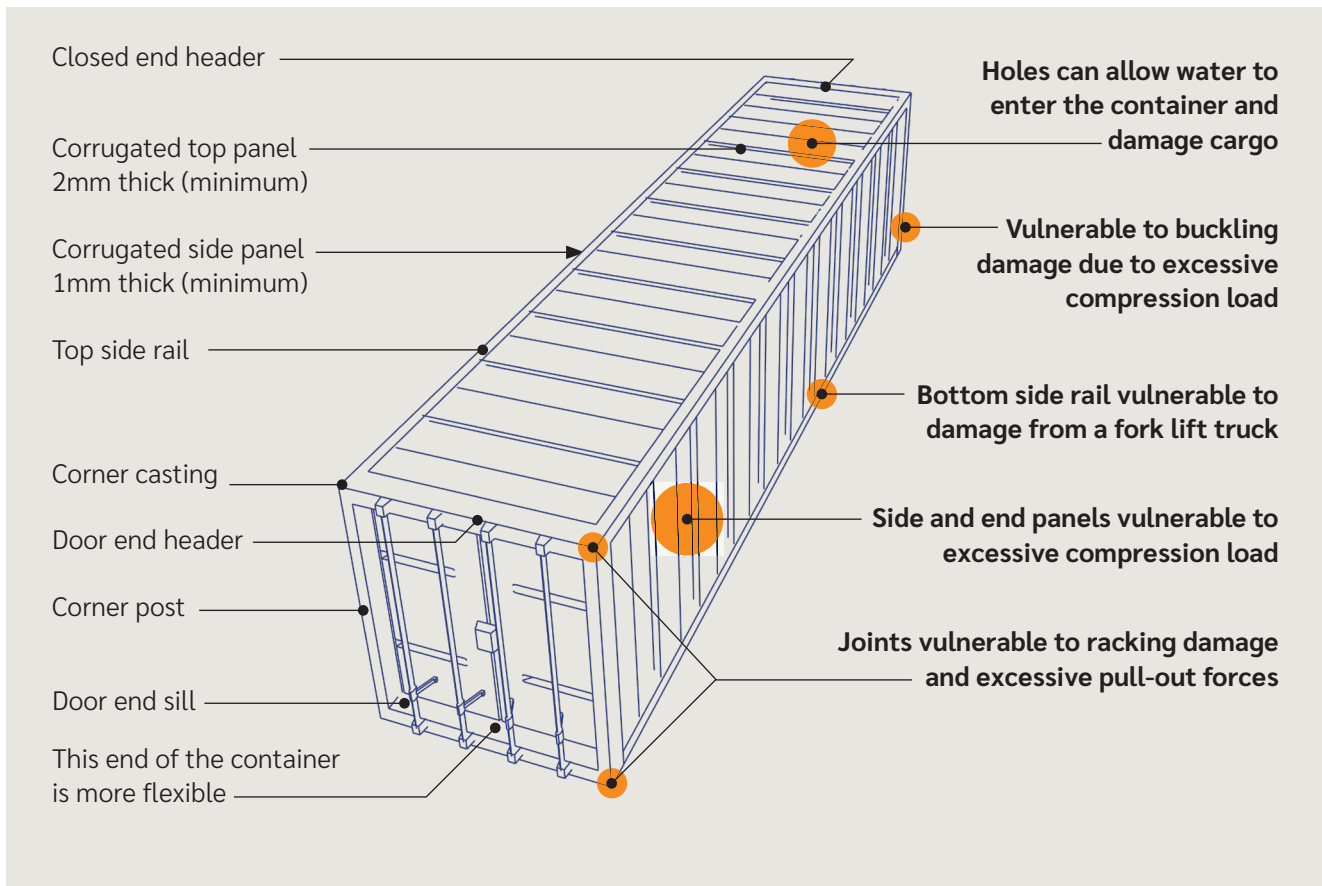

Figure 19: Container construction and faults

It is important to note that a container that has suffered damage to a corner casting or corner post will not be serviceable because:

- a damaged container may be unable to bear the weight of those stowed above it
- a damaged container may render lashings ineffective
- lifting a damaged container is hazardous

If one container in a stack fails, the entire stack will likely collapse.

Certification

Certification is then issued by the classification society for containers of similar design that are constructed by production methods and quality control procedures that are agreed and verified by survey. Changes in the method of construction may nullify the certification unless the changes are approved by the classification society.

Container construction continued

The Lloyd's Register Container Certification Scheme (LR-CCS) covers three general categories of container:

- CSC (Convention for Safe Containers)/ISO Series 1 freight containers – all types
- tank containers for the transport of dangerous goods
- offshore containers

The scheme ensures that each container complies with the appropriate ISO standard and applicable regulations, covering for example:

- dimensions
- strength of walls, floor and roof
- strength of corner posts
- rigidity (longitudinal and transverse)
- weathertightness
- number of other features as appropriate to the type of container, such as the strength of forklift pockets

Container construction



Figure 20: Lloyd's Register logo

A container that has satisfactorily passed the Lloyd's Register Container Certification Scheme will bear the Lloyd's Register logo.

When containers are strength tested, it is important to remember that they are not tested for vertical

tandem lifting and that the corner posts are only tested for compressive strength. Also, it is only the top corner fittings that are tested for lifting; the bottom fittings are never tested. Twistlocks may be approved for vertical tandem lifting; however, such lifting is dangerous and should only be contemplated when a container's bottom corner castings are also approved for lifting. If in doubt, consult the ship's P&I club.

ISO Series 1 freight containers

The primary documents for the design of ISO Series 1 freight containers are:

- ISO 668: Classification Dimensions and Ratings
- ISO 1161: Corner Fittings, Specification
- ISO 1496-1: Specification and Testing. Part 1: General Cargo Containers for General Purposes
- ISO 1496-2: Specification and Testing. Part 2: Thermal Containers
- ISO 1496-3: Specification and Testing. Part 3: Tank Containers for Liquids, Gases and Pressurised Dry Bulk

International Convention for Safe Containers (CSC)

The CSC sets out the standards for freight container construction and use.

The convention contains regulations on construction, inspection, approval and certification.

This includes design approval, a witness of container manufacture and prototype testing, and issuance of a safety plate. The CSC approval or safety plate contains information on the container's date of manufacture, the manufacturer's identification number, the gross operating weight, the allowable stacking weight and the transverse racking load. The plate may also have the end and/or side-wall strength value. The plate is issued when the container is manufactured.

Under the CSC, all containers shall be examined at intervals specified in the convention by one of two ways: either by a 'Periodic Examination Scheme' or under an 'Approved Continuous Examination Programme' (ACEP). Both procedures are intended to ensure that the containers are maintained to the

required level of safety. The maximum period between examinations is set at 30 months or when there is a major repair or modification, and for the ACEP scheme, for on-hire/off-hire interchanges. For tank containers, the ADR (Transport of Dangerous Goods by Road), RID (Transport of Dangerous Goods by Rail) and IMDG (Transport of Dangerous goods by Sea) also have in-service inspection requirements. The standard EN 12972 thoroughly details these requirements.

Certification of reefer containers

The ability of a reefer container to maintain a given temperature when using its integral refrigeration unit is tested in accordance with ISO 1496-2. This consists

of two tests: one to determine the heat loss through the envelope of the container and the other to ensure the refrigeration unit can operate with a specific internal load.

Containers with open doors

Some containers are certified for use with one or both doors open or removed. This may be necessary to ventilate cargo. A note saying the container's doors can be open will appear on the CSC plate under the transverse racking entry. Unless a container is certified to have its doors open, the doors must be closed and secured, as they are an integral part of a container's strength.

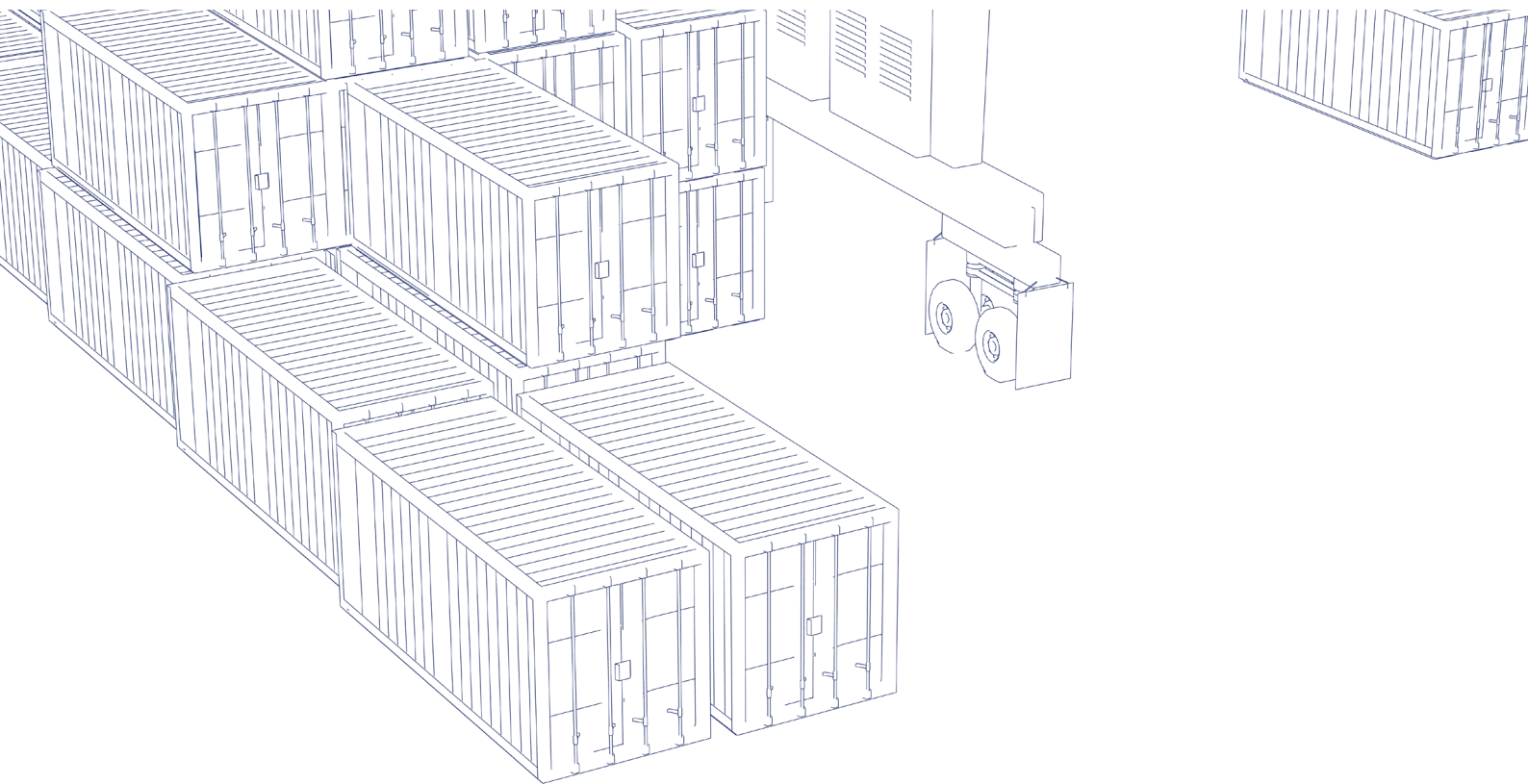

09. Lashing components

A variety of lashing components are available to secure containers, the majority of which are listed below. The table shows the locations where these components are commonly used.

Fixed fitting (attached to ship)







Description	Purpose	Image	Notes
Flush socket	Locating base twistlocks or stacking cones in the cargo hold.		Normally fitted over a small recess to ensure watertightness. Clean and remove debris before use.
Raised socket	Locating base twistlocks or stacking cones on deck.		Clean and remove debris before use.
Lashing plate or 'Pad-eye'	Tie-down point for turnbuckle.		Designed only for in-plane (out-of-line) load could bend the plate and may crack the connecting weld.
D ring	Alternative tie-down point for a turnbuckle.		Corrosion of the pin ends can weaken a D ring. Suitable for in-plane (in-line) and out-of-plane loading.
Dovetail foundation	Base for sliding dovetail twistlock.		Clean before use. Keep well greased and examine regularly for damage or wear.
Fixed stacking cone	To prevent horizontal movement of 20-foot containers in 40-foot cell guides.		Often found at the base of a cell guide.
Dovetail foundation	To prevent transverse movement of 20-foot containers in 40-foot guides. Fitted at tanktop level.		Does not interfere with general stowage of 40-foot containers.

Figure 21: List of lashing components

Loose fittings in common use

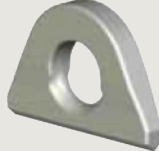
Loose fittings are those that are not permanently attached to the ship. Loose fittings must be certified by class or appropriate recognised authority. However, they are not normally surveyed by the classification society during regular ship surveys. When using loose fittings, it is essential that the manufacturer's instructions are always followed, especially when using fully automatic and semi-automatic twistlocks.



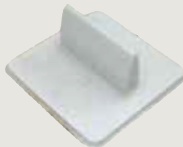

Description	Purpose	Image	Notes
Lashing rod	To provide support for container stacks on deck. Used in conjunction with a turnbuckle.		Resists tensile loads. Very long lashing rods can be difficult to handle and difficult to locate in a container corner casting. They have eyes at each end.
Extension piece	To extend a lashing rod when securing 'high cube' containers.		Fit at the base of a lashing rod and connect to the turnbuckle.
Turnbuckle (bottle screw)	To connect a lashing rod to a flashing plate or D ring. Tightening puts tension into a lashing rod.		Resists tensile loads and is used to keep the lashing tight. Regularly grease its threads. Ensure the locking nut or tab is locked.
Hanging stacker	Used in holds where 20-foot containers are carried in 40-foot guides. Locks into corner casting above.		Resists horizontal forces. Likely to be put in place when container is on shore because of difficulty in fitting when on board.
Semi-automatic twistlock (SAT)	Placed between containers in a stack. Locks into corner casting above and below.		Resists horizontal and separation forces. Can be fitted on shore. Automatically locks into the lower container when placed on top. It is easier to determine whether it is locked or not when compared to manual twistlocks. Unlocked manually.

Figure 22: List of portable lashing equipment

Lashing components continued





Description	Purpose	Image	Notes
<p>Twistlock</p>	<p>Placed between containers in a stack. Locks into corner castings above and below.</p>		<p>Resists horizontal and separation forces. Each fitting requires locking and fitting. Left and right-hand types exist, causing uncertainty whether a fitting is locked or open.</p>
<p>Stacking cone</p>	<p>Placed between containers in a stack. Slots into corner castings.</p>		<p>Resists horizontal forces. Many types exist. May be locked into bottom corner castings prior to lifting a container on board.</p>
<p>Fully automatic twistlock (FAT)</p>	<p>Placed between containers in a stack. Locks into container casting above; hooks into container casting below.</p>		<p>Automatic unlocking during lifting. Usually opened by a vertical lift, with a twist/tilt. Should not be used if container corner castings are worn or damaged.</p>
<p>Mid-lock</p>	<p>Placed between containers in a stack. Locks into corner castings above and below. Used on deck between 20-foot containers in 40-foot bays, at mid-bay position.</p>		<p>Resists horizontal and separation forces. Fitted to underside of container on shore and automatically locks into lower container when placed on board. Consult the manufacturer's instruction manual for information on the lock's correct direction of fitting.</p>

Figure 23: List of portable lashing equipment

Loose fittings in less common use

These fittings are not commonly used but may be encountered occasionally. Fitting a bridge piece requires access to the container top, something that should be avoided unless it is necessary.







Description	Purpose	Image	Notes
Sliding dovetail twistlock	To connect bottom containers to the ship.		Fits into a dovetail foundation. Used on hatch covers and in holds where a raised socket could cause an obstruction.
Bridge fitting	To link together the top of the containers of two adjacent stacks. Can be used on deck or in a hold.		Resists tensile and compressive forces. Potential drop hazard for stevedores/crews during placement.
Buttress	External support for container stacks in a hold.		Can resist compressive and tensile forces. Must be used with higher-strength double stacking cones or link plates and aligned with side support structure.
Double stacking cone	To link adjacent stacks, particularly those in line with buttresses.		Resists horizontal forces. More commonly used on con-bulkers below deck.
Load equalising device	To balance the load between two paired lashings.		Enables two parallel lashing rods to be connected to a single turnbuckle. Only use with designated lashing rods.
Penguin hook	Used as a supporting device in conjunction with a special lashing rod with an eye-end.		Likely to be put in place when a container is on shore because of difficulty in fitting when on board. Risk of injury if it falls out when container is lifted onboard.
Elongated socket	Locating base twistlocks or stacking cones on deck.		Enables movement between a hatch cover and container to be taken up.

Figure 24: List of portable lashing equipment

Lashing components continued

Lashing components

1. Twistlock
2. Turnbuckle
3. Lashing rod
4. Single raised socket
5. Double raised socket
6. Lashing plate

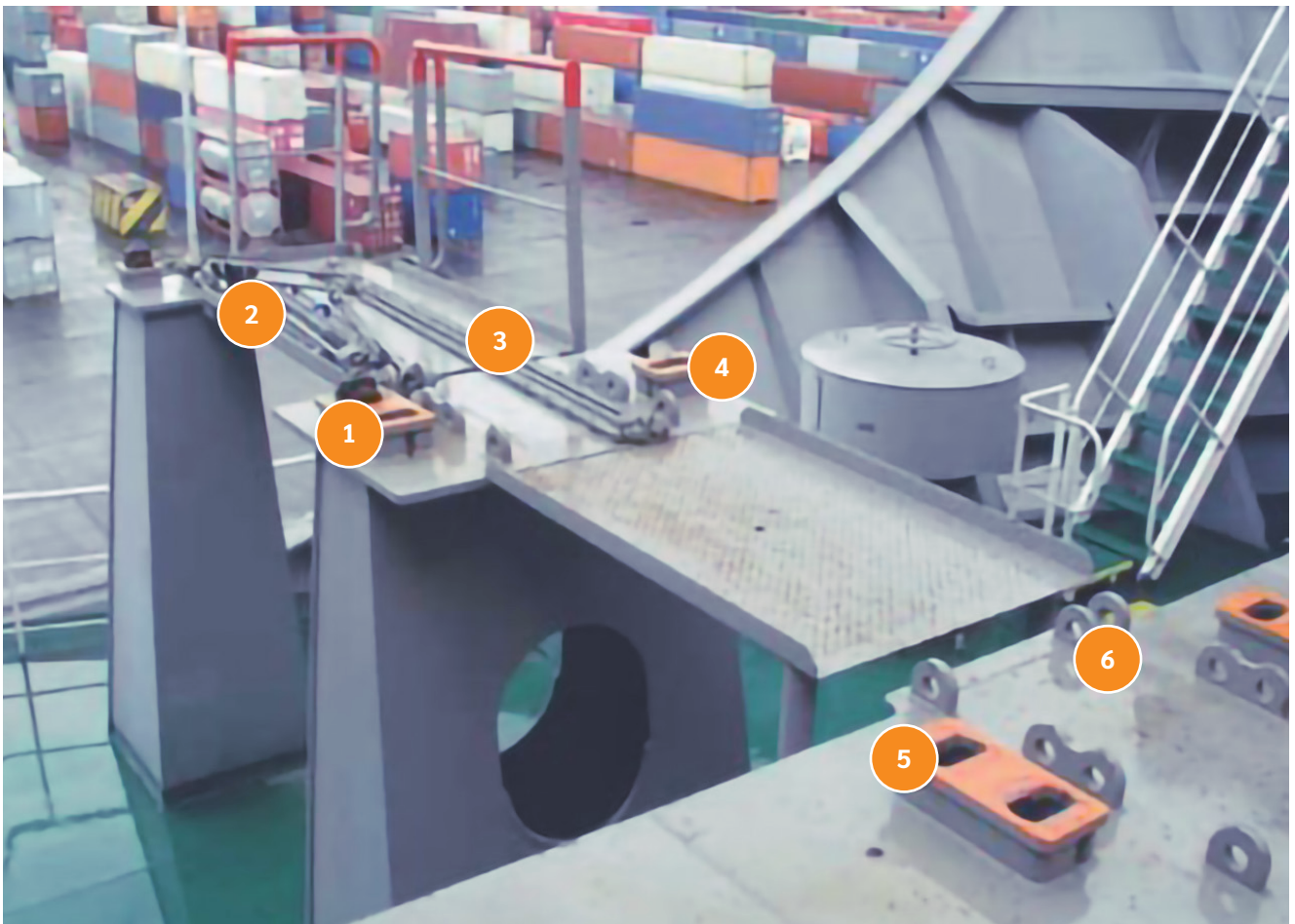

Figure 25: Lashing components

Lashing components continued

1. D rings
2. Dovetail foundation
3. Turnbuckle

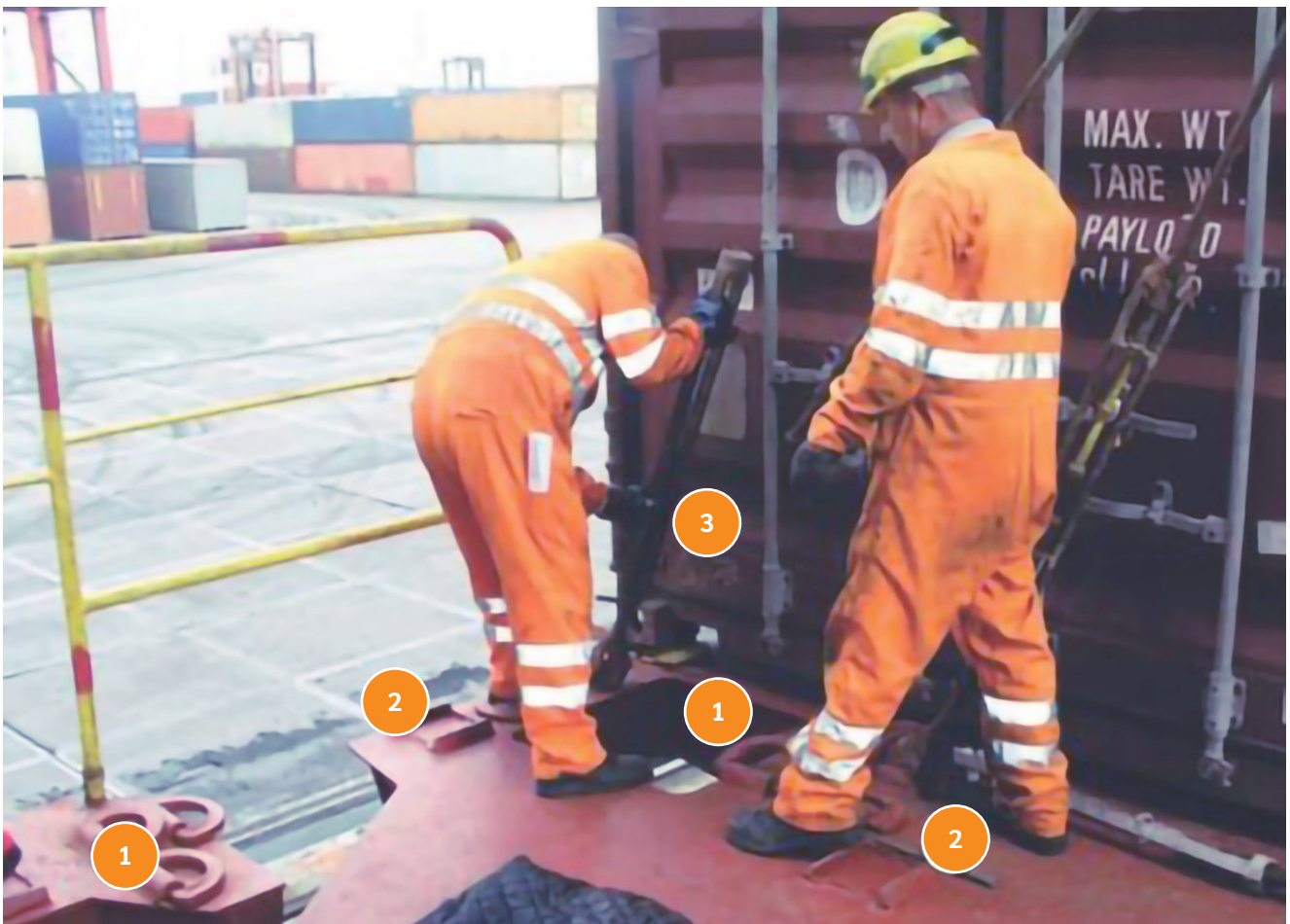

Figure 26: Lashing components

10. Principles of stowage

Containers are rectangular box-shaped units of cargo. It is easy to stow them in classical block stowage both on and below deck.

Containers are carried on the decks of ships approved for that purpose and are secured with twistlocks and lashings. The lashings usually consist of steel rods and turnbuckles.

When containers are carried below deck, the containers are slotted into cell guides on a cellular container ship, or sit on the tank top, joined together with stacking cones, in the holds of a dry cargo ship. Containers can easily be stowed in box-shaped holds. It is more difficult to carry them in the holds of a dry cargo ship fitted with side hopper tanks, in which case, buttresses may be fitted.

When carried within a cell guide framework, no further external support is generally required. When 20ft containers are stowed below deck in 40ft cell guides, it may be beneficial to overstow the 20ft containers with a 40ft container. The Cargo Securing Manual should be consulted before loading.

The horizontal movement of a deck stow is resisted by the twistlocks. Lifting of containers in extreme seas is prevented by the pull-out strength of the twistlocks. The limitation of a twistlock-only stow is often the racking strength of the containers. For stows of more than three containers high, lashing rods are fitted to provide additional racking strength.

In the early days of containerisation, lashings were fitted vertically to resist tipping. However, it soon became clear that it is more effective to arrange the lashings diagonally so that the container and the lashings work together to resist racking.

The usual arrangement is to fit one tier of lashings, placed diagonally within the width of the container, with the tops of the lashing rods placed in the bottom corner castings of the second tier containers. This is called 'cross-lashing'. An alternative arrangement, with the lashing rods located outside the width of the container, is called 'external lashing'. This is often used for high stacks that are lashed from a two tier lashing bridge.



Figure 27: Assorted twistlocks

To enable the fitting of twistlocks, a twistlock is designed with a vertical and horizontal gap between it and a container's corner casting. This becomes important when considering how lashings behave during ship roll, pitch and heave. Lashing rods are always fitted tight and kept tight by adjusting the turnbuckle. When force is transmitted to securing equipment during ship rolling, it is the lashing rods that bear the force first. It is only after the stack of containers has deflected and the gap at the twistlock has been 'taken up' that twistlocks become tight. For this reason, it is important to only use lashing rods that are in good condition and to apply them correctly. This is critical for external lashing, where the lashing rods are connected to the tension side of the container stack.

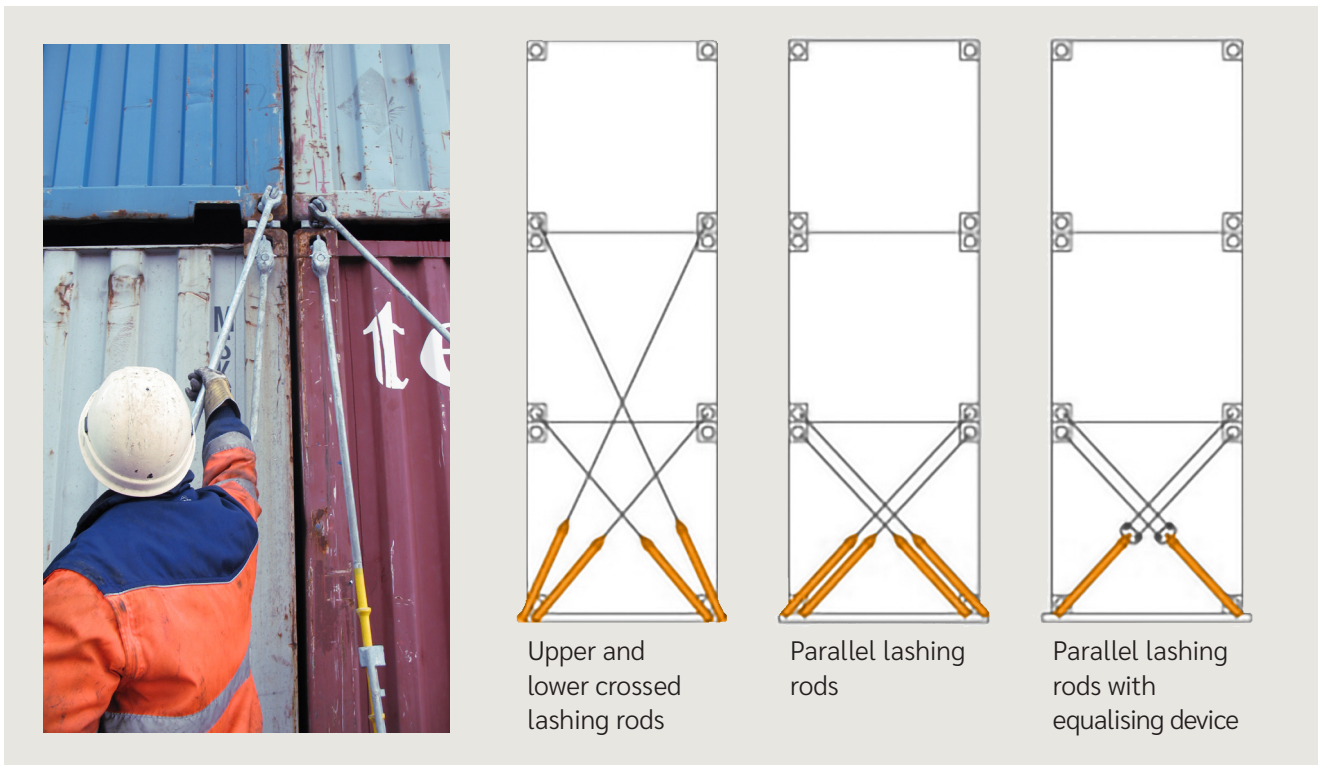

Figure 28: Securing with parallel lashing rods and semi-automatic twistlocks

The second set of lashings may be fitted, to the bottom of the third tier of containers, as shown in the diagram.

If additional lashing strength is required, parallel lashings (para-lashings) may be used. With this arrangement, lashings are arranged in parallel, with one fitted to the top of the first tier and one to the bottom of the second tier. Tests have revealed that many containers are not able to bear large downward loads on the upper castings, as can occur with para-lashings. This is particularly the case at the door end, where the upper casting frequently overhangs the door and consequently has little support. Modern lashing calculations automatically consider the impact of this double lashing configuration.

For ease of loading and discharge, bridge fittings that link adjacent stacks of containers together are not commonly fitted. However, since the force distribution and the response of adjacent container stacks will be similar, there is, in general, negligible load transfer between the stacks when linked together.

Bridge fittings tend to be used only on isolated stacks of containers in the holds of dry cargo ships.

The ship's Cargo Securing Manual contains information on how to stow and secure containers, and on any strength or stack weight limitations.

Principles of stowage continued

The most common mistakes made are to exceed the permissible stack weight, to incorrectly apply lashings and to place heavy containers near the top of a stow.

Containers carried below deck in cell guides

The cargo holds of most container ships are designed for 40ft containers, with the containers held in place by cell slides. The cell guides are generally steel angle bars orientated vertically, with entry guides at the top to assist with locating the container. The clearances, and hence construction tolerances, are very tight.

The cell guides provide adequate longitudinal and transverse support to the 40ft containers and no further securing arrangements are necessary. The lowest container in each stack sits on a pad, which is supported by the stiffened structure below the tank top.

Twenty-foot containers may be stowed in 40ft bays. This arrangement, referred to as mixed stow, requires longitudinal and transverse support for the containers where they meet at the mid-length position. This is achieved by mid-bay guides at the tank top, placing hanging stackers between tiers of containers and possibly over-stowing two 20ft containers with one or more 40ft containers. Isolated stacks should be avoided. In general, four hanging stackers should be fitted below each container, unless the Cargo Securing Manual specifically permits a lesser number. The current Lloyd's Register Rules and Regulations for the Classification of Ships, Part 3, Chapter 14 propose diagonal stacking cone arrangement as being the most effective and implement separate tables for this stacking cone arrangement.

Before loading containers in cell guides, it is important to make sure that the guides are not bent or deformed.

Typical arrangements for containers stowed below deck

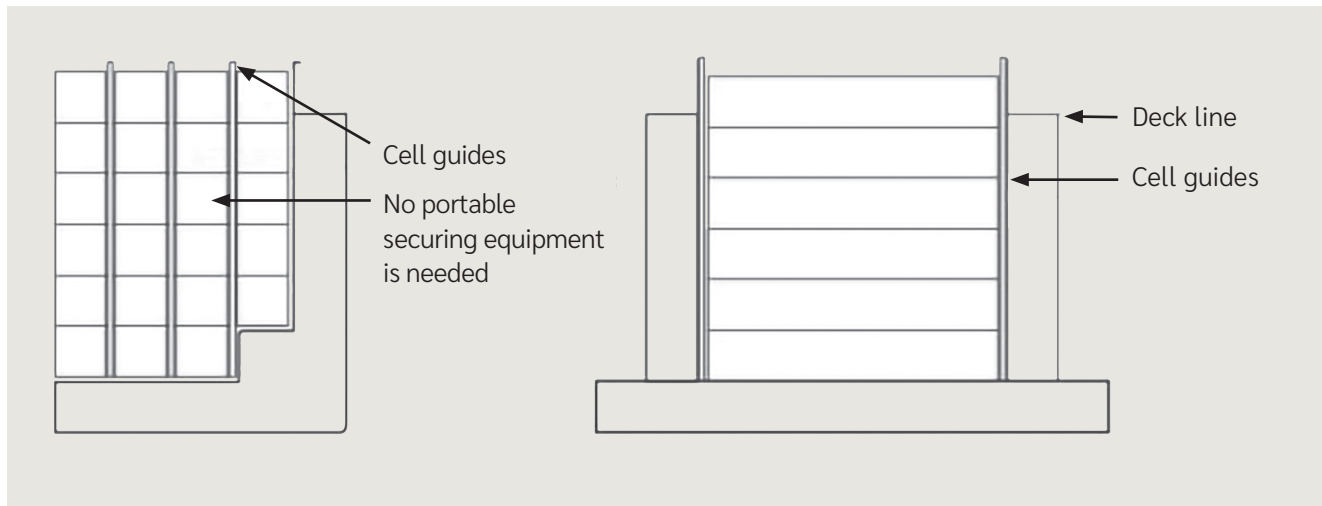

Figure 29: 40ft containers in 40ft cell guides

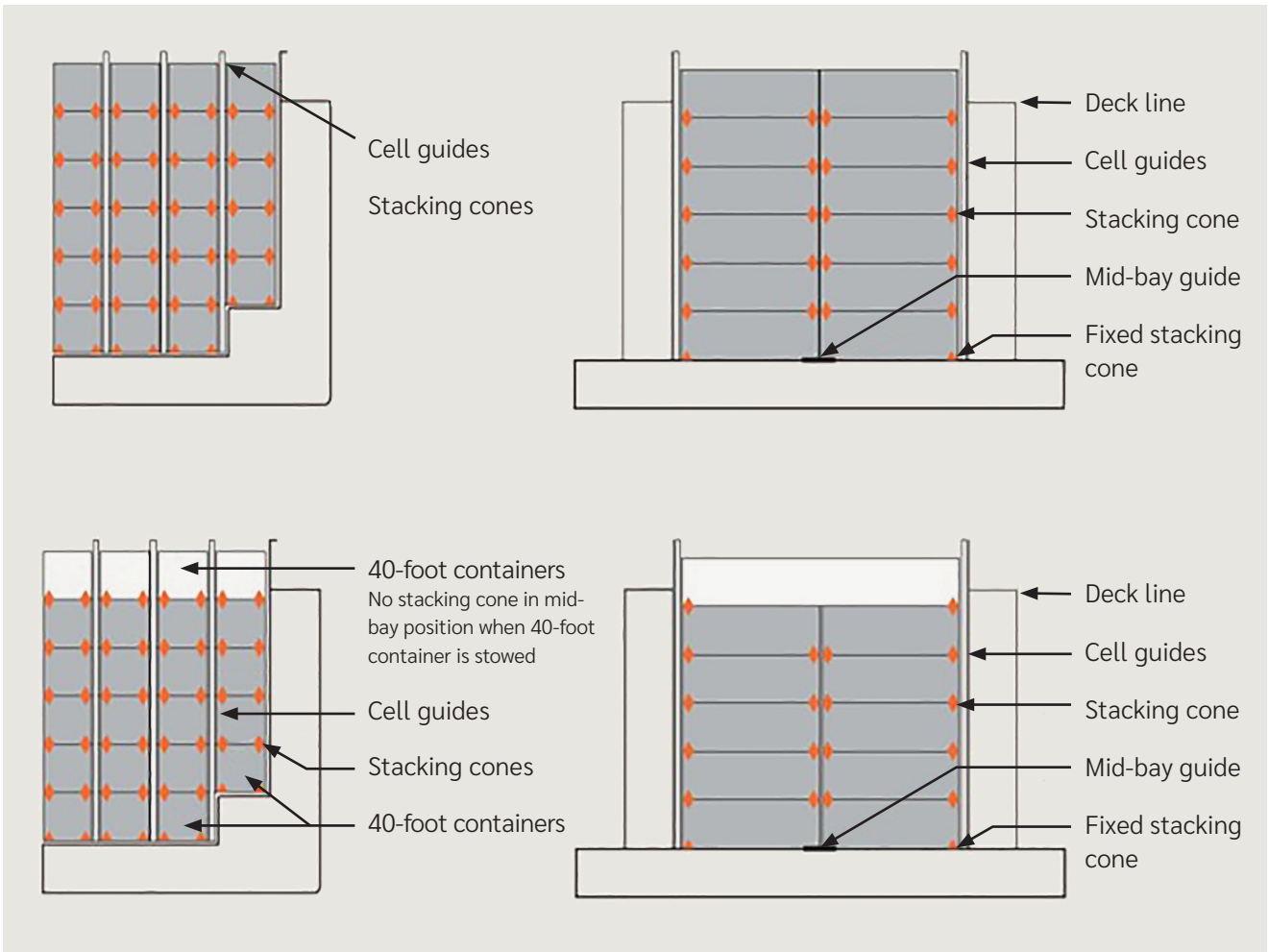

Figure 30: 20ft containers in 40ft cell guides with 40ft containers stowed above

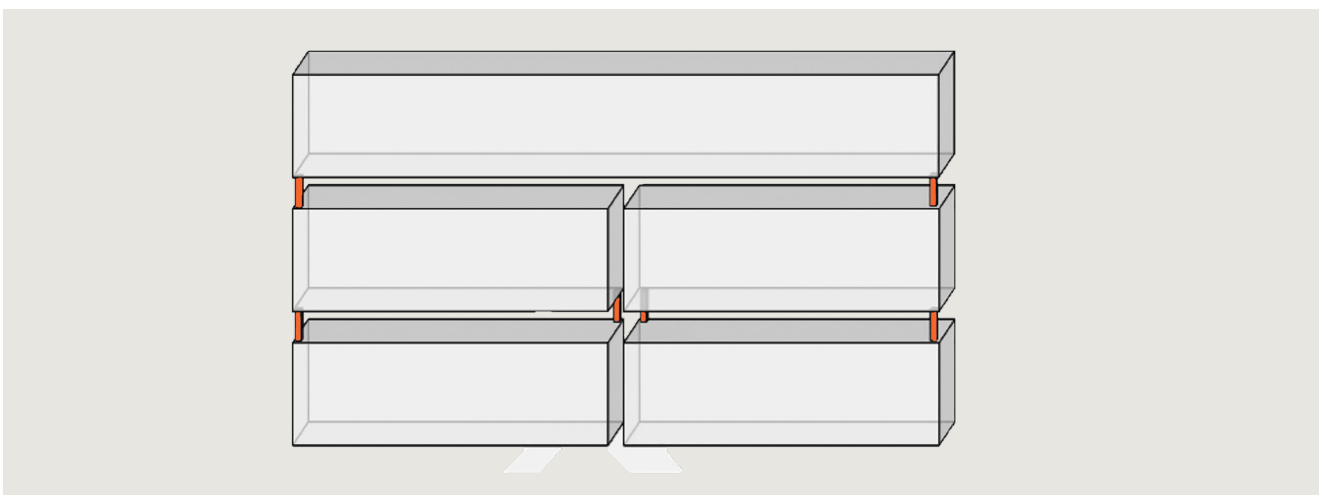

Figure 31: 20ft containers stowed in 40ft cell guides with overstay, diagonal stacking cone arrangement

Principles of stowage continued

Containers carried below deck without cell guides

Containers are generally stowed in the fore and aft direction and are secured using locking devices only or by a combination of locking devices, buttresses, shores or lashings. The aim is to restrain the containers at their comers. Twistlocks are very good at preventing corner separation.

When carrying containers in the hold of a bulk carrier or general cargo ship, base containers are secured with twistlocks or cones. Buttresses should be fitted to provide lateral support. A platform, with sockets for cones or twistlocks, may be fitted in the forward and aft holds. This forms the basis for block stowage of containers when combined with cones, twistlocks and bridge fittings.

Various designs of portable buttresses are available. Aim for a tight block when loading containers below deck on a con-bulker. During loading, check to make sure that means are applied to ensure that the lowest tier does not slide when the ship rolls.

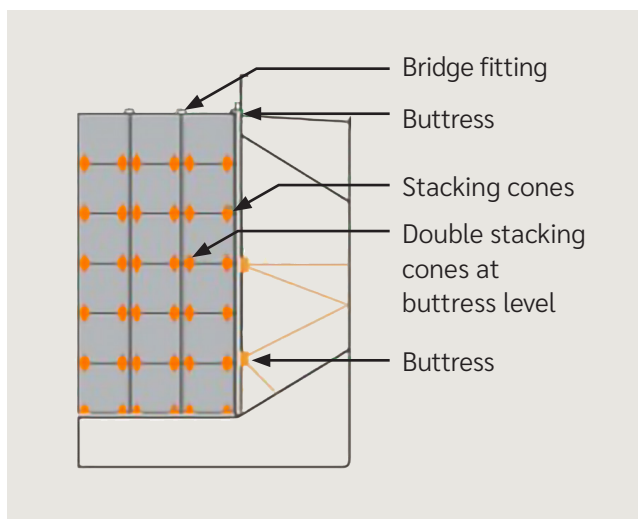

Figure 32: Typical bulk carrier stowage arrangement with buttresses, using single/double stacking cones and bridge fittings

Containers carried on deck

Containers are usually stowed longitudinally in vertical stacks.

Containers within each stack are fastened together with twistlocks. The bottom corners of each base container are locked to the deck, hatch cover or pedestal with a twistlock. When stacked in multiple tiers, the containers are usually lashed to the ship's structure by diagonal lashing rods.

The rods are usually applied to the bottom corners of the second tier or third tier containers. On ships fitted with lashing bridges, the lashing rods are applied to containers higher up the stack.

Lashings are applied so that each container stack is secured independently. However, failure of an individual stack has the potential to wipe out an entire bay resulting in a large number of container losses. It is crucial to ensure each stack is correctly stowed and secured as the bay will be only as strong as the weakest stack. Transverse stowage, although possible, is uncommon, mainly because cargo could move or fall out of the container when the ship rolls, but also because transverse stowage requires rotation of the spreader bar of the shore gantry crane.

In some cases, containers are carried on deck in cell guides, in which case, the principles on page 32 apply. The same principles also apply to hatchless container ships.

Containers at the sides of the ship are subject to wind loading. Consequently, it is common for 'wind lashings' to be fitted. These may be vertical or diagonal. It may also be necessary to fit wind lashings inboard if there are vacant stacks. The container securing arrangement (CSA) or lashing software should be followed.

Typical arrangements for containers stowed on deck

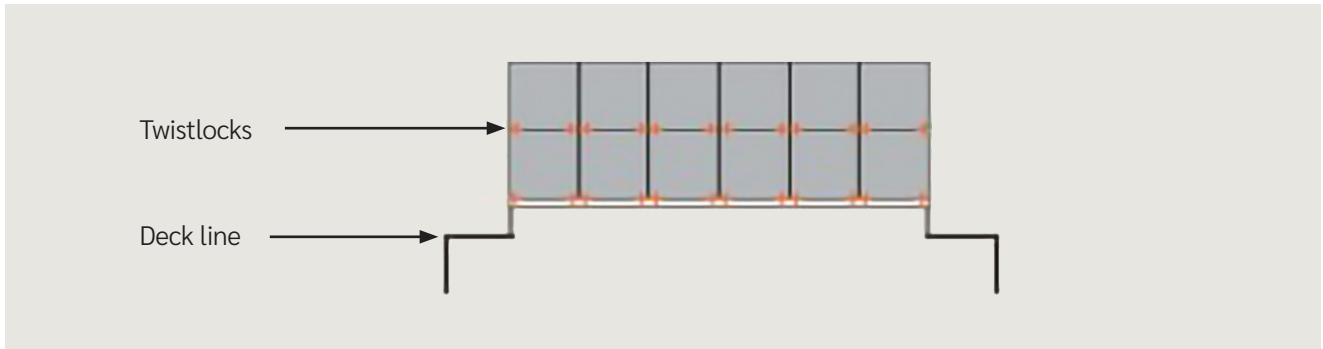

Figure 33: Containers secured by twistlocks. Usually for two tiers only

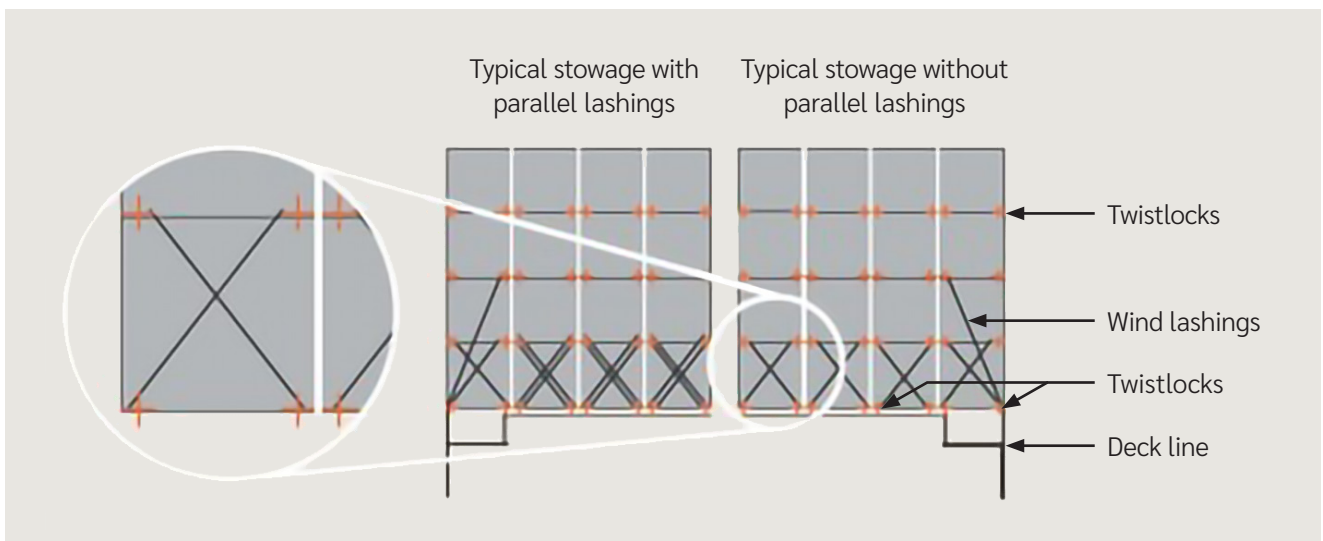

Figure 34: Containers secured by twistlocks and lashing rods. Lashing rods to bottom of second tier. Wind lashings to bottom of third tier

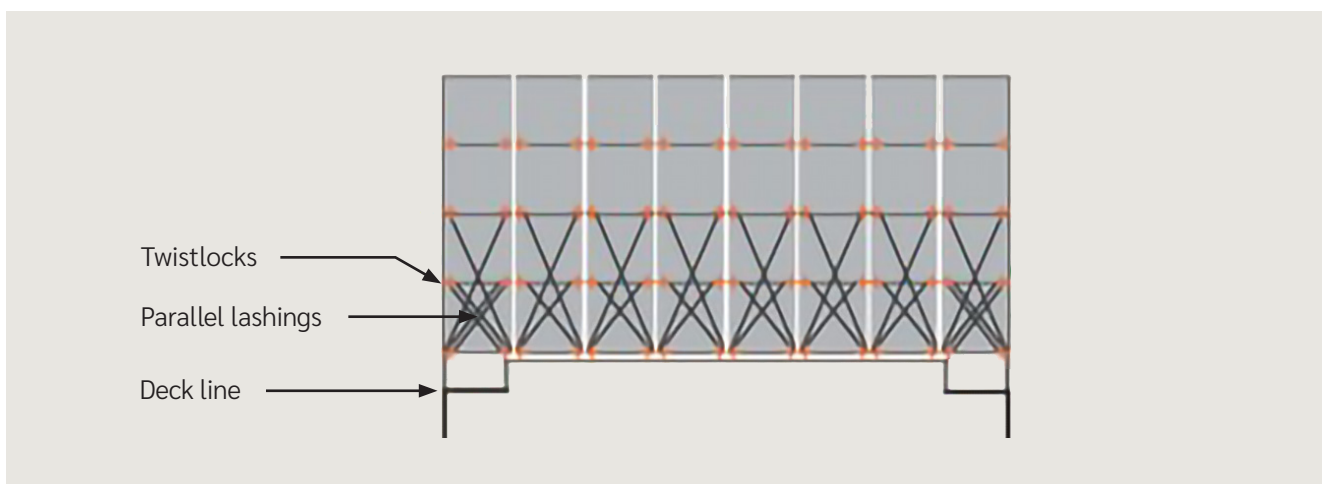

Figure 35: Containers secured by twistlocks and lashing rods. Lashing rods to bottom of third tier

Principles of stowage continued

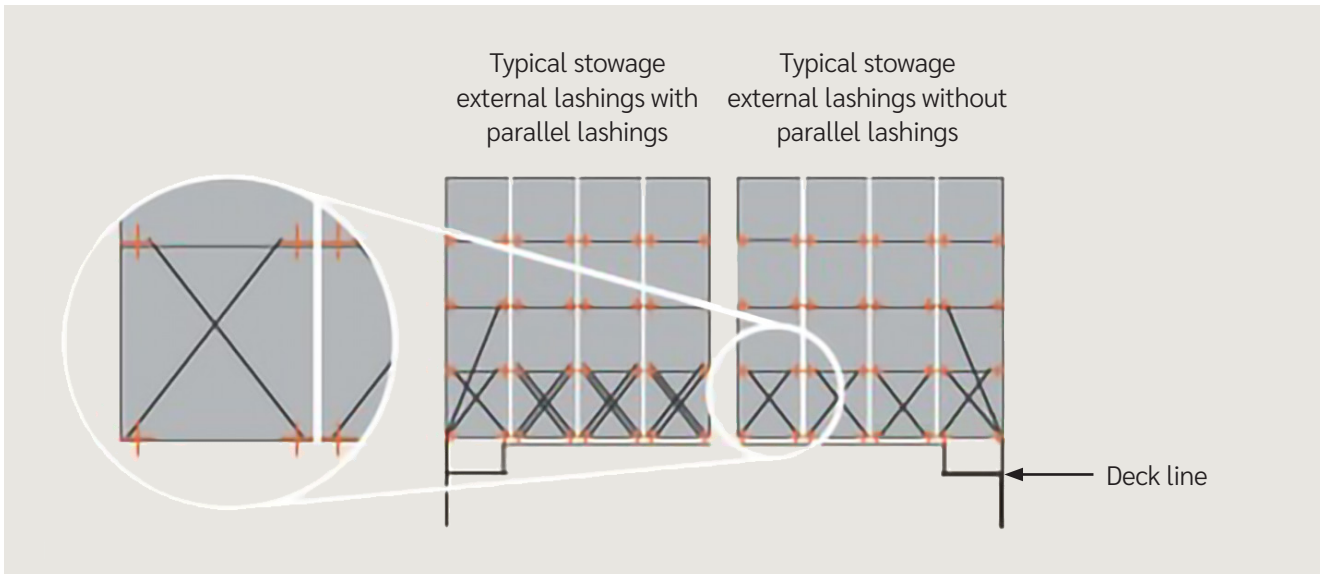

Figure 36: Container secured by twistlocks and lashing rods. 'External lashing' arrangement

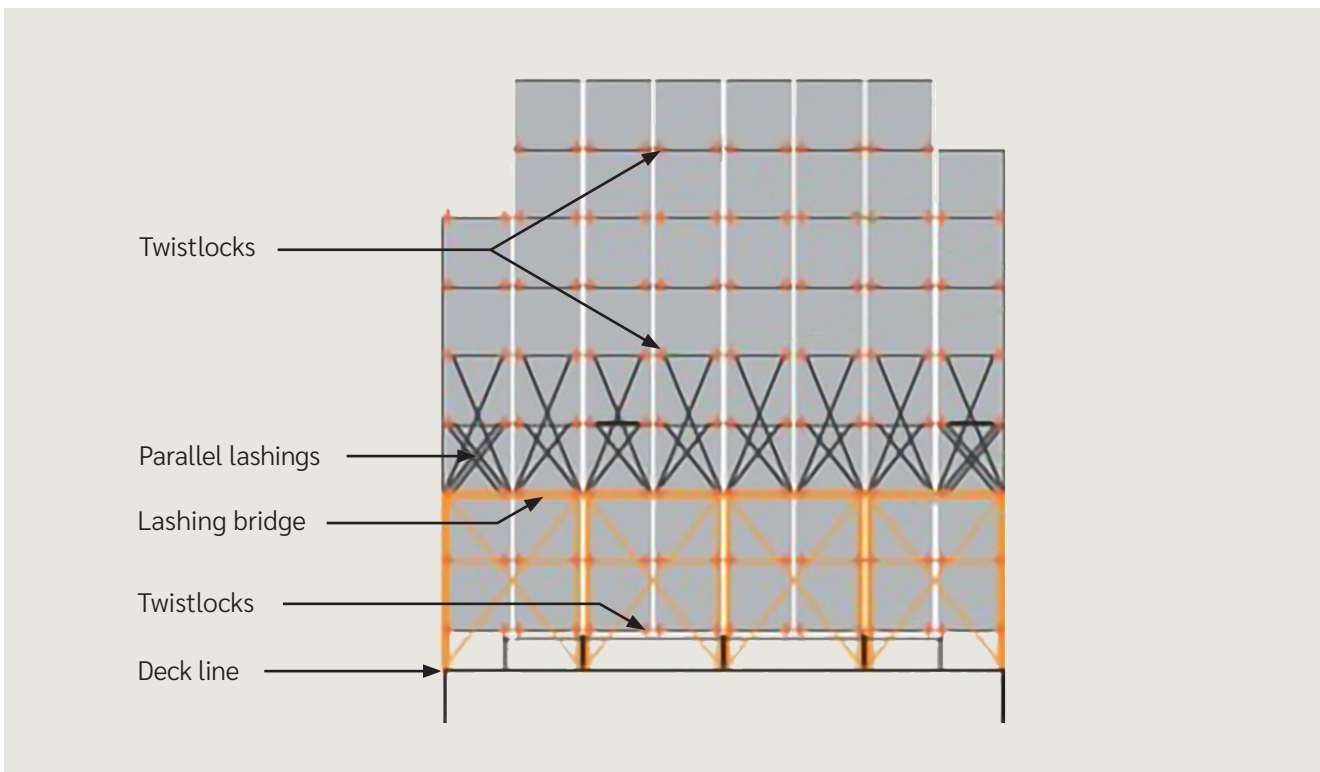

Figure 37: As for Figure 36 above but lashings originate from lashing bridge. Lashing rods to bottom of fifth tier

When stowing and securing containers, the following points should be borne in mind:

- A deck stack of containers is only as strong as the weakest component in that stack. Premature failure of a component can cause loss of an entire stack. During loading, containers should be inspected for damage and, if damaged, they should be rejected.
- Twistlocks limit vertical and transverse movement. Diagonally crossed lashing rods, placed at the ends of a container, can withstand large tensile loads.
- Outside lashings are sometimes used. These are lashings that lead away from a container. This arrangement provides a more rigid stow than a combination of crossed lashings and twistlocks and is common on all large container ships.
- Containers exposed to wind loading need additional or stronger lashings. When carried in block stowage, it is the outer stacks that are exposed to wind loading. However, when carried on a partially loaded deck, isolated stacks and inboard containers can also be exposed to wind, in which case, additional lashings need to be applied.
- If containers of non-standard length, that is, 45ft, 48ft or 53ft are carried, the ship arrangement will need to be specially adapted.
- 45ft containers fitted with additional corner posts at 40ft spacing can be stowed on top of 40ft containers. Lashings can be applied in the normal way. It should be noted, however, that the additional corner posts may not be suitable for carrying the required loads, either from the container itself or from those stowed above. Lashings should not be applied to the overhang. The container specification and the Cargo Securing Manual should be consulted.
- 40ft containers may be stowed on top of 45ft containers. However, this arrangement of stowage will present difficulties in fastening/unfastening twistlocks, and it will not be possible to apply lashings to the 40ft containers.
- When carrying over-width containers, for example, 45ft or 53ft containers with a width of 8ft 6in, adaptor platforms may be used. These must be certified by a classification society or an appropriate recognised body. The arrangement must be defined and approved in the ship's Cargo Securing Manual.
- Twistlocks should always be locked, even when the ship is at anchor, except during container loading and unloading. Lashing rods should be kept taut and, where possible, have even tension. Lashing rods should never be loose nor should they be overtightened. Turnbuckle locking nuts should be fully tightened.
- As a ship rolls, pitches and heaves in a seaway, tension, compression and racking forces are transmitted through the container frames, lashings and twistlocks to the ship's structure. However, clearances between securing components and the elasticity of the container frame and lashing equipment produce a securing system that forms a flexible structure. Thus, a deck stow of containers will move.
- Arrangements with automatic and semi-automatic twistlocks are used to reduce time spent securing the stow and to eliminate the need for lashers to climb the stacks.

Principles of stowage continued

Checks and tests during discharge and loading

- Regularly examine lashing components, looking for wear and tear, damage or distortion. Check that left-hand and right-hand locking twistlocks are not being mixed in the same storage bin. Remove from the ship any lashing component found to be worn, damaged or distorted.
 - Plan for some damaged or distorted lashing components to be sent for non-destructive testing. This will determine their strength and help to establish replacement criteria.
 - Carefully check twistlocks that stevedores return to the ship, as the locks might not originate from your ship, that is, their strength and locking direction could differ.
 - Discourage stevedores from treating lashing equipment roughly, as this can induce weakness.
 - Examine dovetail foundations, D rings and pad-eyes for damage. Repair if damage is found.
 - Observe the loading of containers to determine if stowage is in accordance with the stowage plan and that best practice is always followed.
 - Observe the application of lashings to make sure that they are correctly applied in accordance with the requirements set out in the Cargo Securing Manual.
- It is not recommended to store loose fitting storage bins on top of the stacks, however if unavoidable, their weights must be included in the container stack assessment.
 - Make an inventory of lashing equipment and order spares before they are needed.
 - Check that refrigerated boxes remain connected to the ship's power supply.

Checks and tests at sea

- 24 hours after sailing, examine, check and tighten turnbuckles. Check that lashings are applied in accordance with the Cargo Securing Manual and that twistlocks have been locked.
- Examine lashings daily. Check that they have not become loose and tighten turnbuckles as necessary.
- Before the onset of bad weather, examine lashings thoroughly and tighten turnbuckles, being careful to keep an equal tension in individual lashing rods.
- Recheck lashings after passing through bad weather.
- Make sure that lashing equipment that is not in use is correctly stored in baskets or racks.



Figure 38: Transport of 40ft container

Very large container ships

The size of very large container ships brings its own problems regarding the number of containers on the deck that require lashing.

The increased number of containers on these ships means that there is much more portable and fixed lashing equipment required to be inspected, maintained, tallied and segregated.

It also brings inordinate difficulties for the crew who are responsible for monitoring the stevedores lashing deck containers, and checking and verifying that the extremely numerous lashing arrangements are correct and in accordance with the Cargo Securing Manual (CSM) or, in most cases, the approved lashing software.

The ship's staff may also consider this task as mundane and of little importance, and that if the containers are lost, there will be little danger to the ship. Stevedores may not be interested in handling the lashing carefully, which coupled with the speed of operation required, could result in the lashing equipment becoming damaged. This makes keeping on top of maintenance and segregating damaged equipment difficult.

The increasingly large number of containers to lash and unlash increases the time taken to perform this work. Fully automatic twistlocks (FATs) is being used to reduce the manpower and the time needed to complete the lashing and unlashing operation.

FATs are not without their issues. The type that is engaged and disengaged with a slew of the container on its vertical axis is linked with container losses overboard. However, if the correct type of FATs and their application for use onboard has been verified, there is no reason why they cannot be used.



Figure 39: FATs removed and fitted ashore

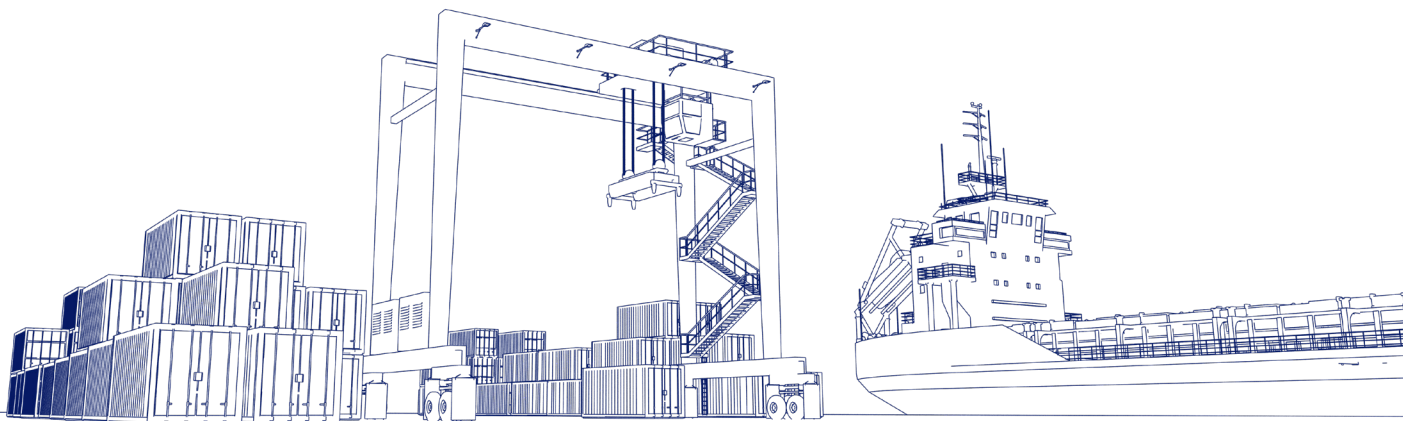

11. Ship behaviour

Container ships, due to the nature of their trade, are required to keep to very tight operating schedules. Maintaining the schedule is an important part of the liner trade. As a result, these ships have powerful engines to provide the high speeds required.

A consequence is that, at times, container ships can be driven hard. When ships are driven hard in bad weather, the loads on the lashings can be severe.



Figure 40: Container ship operator must know the container stacks' design roll angle

The container ship operator needs to know the container stacks' design roll angle used to determine the safety of the container stacks. Exceeding this roll angle will significantly increase the risk of stack failure and loss of containers. The container stacks' design roll angle will vary for the GM of the vessel as well as for route and season specific loading.

Alteration of the vessel's course and speed to keep the vessel's roll motion below the container stacks' design roll angle is important to ensure safe operation.

There are many load components arising from a ship's motion. These are discussed below.

Ship's structure

The combined weight of a stack of containers may amount to a total downward force on the tank top, through each container corner casting, of up to 100 tonnes. When four container corners are placed close together, such as at the mid-hold position when

carrying 20ft containers, the total local load on the tank top may be four times this load.

During classification, the strength of the ship's structure to support containers is verified and approved. This includes an assessment of the strength of the tank top, the cell guides and, on deck, the strength of the hatch covers, lashing bridges, pedestals and the fixed fittings associated with the container stow.

It is important to carry containers within the loading conditions imposed by the classification society. Container loads should never exceed the limits set down in the ship's loading manual.

Container strength and ship motion

Although a ship has six degrees of motion, it is roll, pitch and heave that produce the most significant contributions to the forces on a container stow. Surge is important for road and rail transportation and containers are designed with this in mind.

The motion of a ship in irregular seas is itself irregular and is impossible to accurately predict. Consequently, when calculating accelerations on a stack of containers, a regular cyclic response is assumed in association with assumed maximum amplitude. Empirical formulae for maximum amplitude and period of response are defined in the Rules and Regulations for the Classification of Ships by Lloyd's Register. The rolling motion is dominant in the calculation of forces, but rolling must be considered in association with the other components of the ship's motion to establish the largest likely combination of forces that the stow may experience.

For calculation purposes, the forces acting on a container may be resolved into components acting both

parallel to, and perpendicular to, the vertical axis of the container stack. Gravity acts vertically downwards and, therefore, when the stack is inclined at maximum roll or pitch, there are force components of static weight acting both parallel to, and with, the vertical axis of the stack. The dynamic components of force are vectors. These are combined algebraically with the static component.

Wind load should consider the 3D effect of the wind over the top of the container. Therefore, there is an expected reduction in the wind load on the upper containers in the stack. The assessment of the effect of green seas on exposed container stacks is by necessity empirical. The general principle is to require the container securing arrangement in the forward quarter of the ship to be suitable for forces increased by 20%, except when the ship has an effective breakwater or similar.

Calculations of forces acting on a container consider various combinations of the individual components of motion. Within each combination, it is necessary to define the instantaneous positions in the cycle of motion at which the calculations are made.

Of course, in an actual seaway, all components of motion act simultaneously to a greater or lesser extent.

Lloyd’s Register Rules: allowable forces on an ISO container

The loading exerted on the containers is distributed throughout the stack based on the stiffness of the containers, twistlocks, lashing rods and lashing bridge structures. Lloyd’s Register Guidance Notes for Calculation Procedure of Container Stack Analysis describes an approach to determine the internal forces.

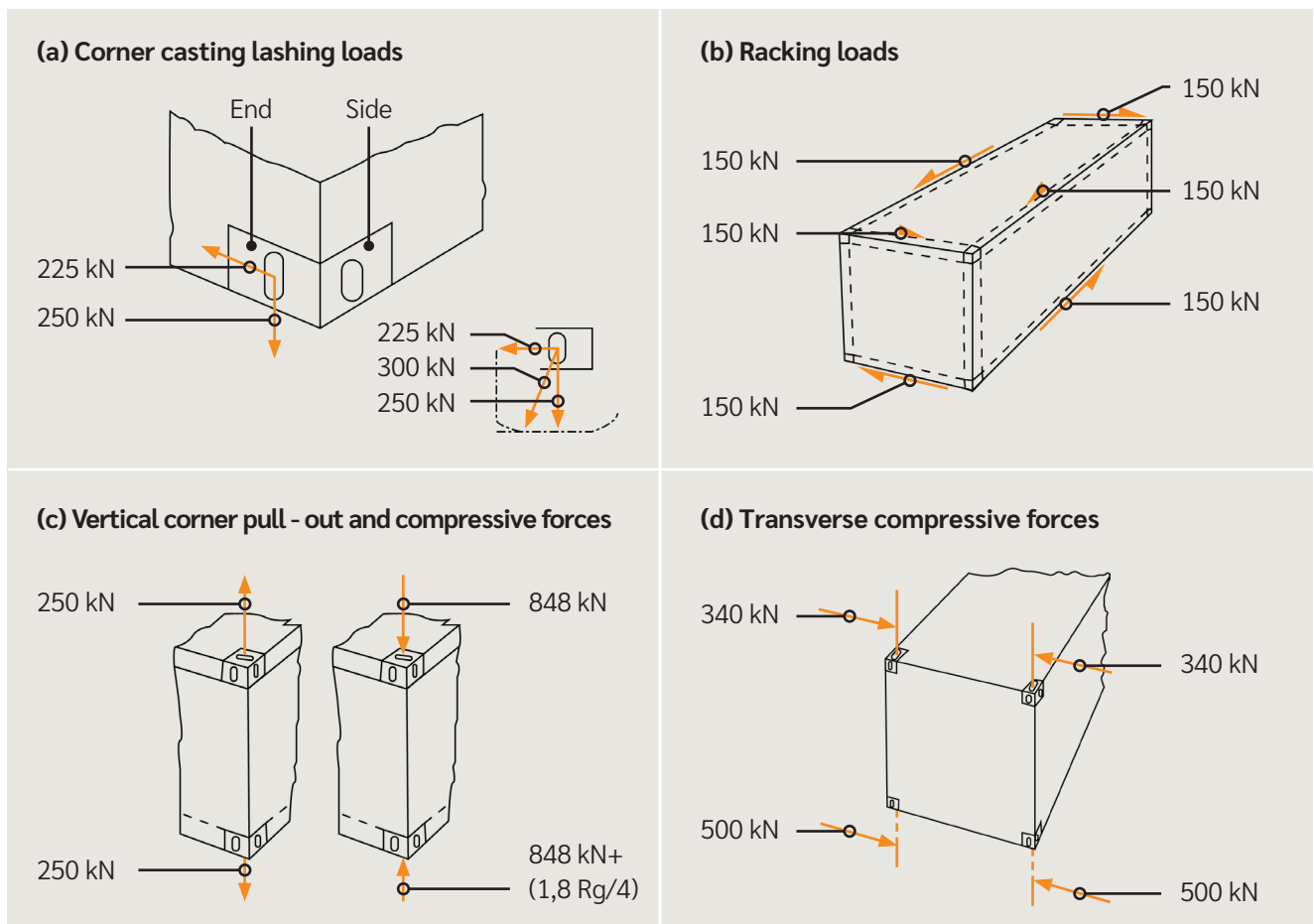

Figure 41: Forces on 20ft or 40ft containers

Ship behaviour continued

Parametric rolling

The term parametric roll is used to describe the phenomenon of large, unstable rolling, which can suddenly occur in head or stern quartering seas. Due to its violent nature and the very large accelerations associated with the onset of parametric rolling, there is widespread concern for the safety of container ships. Possible consequences include loss of containers, machinery failure, structural damage and even capsizing.

Parametric roll is a threshold phenomenon. This means that a combination of environmental, operational and design parameters need to exist before it is encountered. These are:

- ship sailing with a small heading angle to the predominant wave direction (head or stern quartering sea)
- the wavelength of the predominant swell is comparable to the ship's length
- wave height is large
- ship's roll-damping characteristic is low

If resonance occurs between the wave encounter period and the natural, or twice natural, roll period of the ship, then parametric roll motion can be experienced.

Under parametric roll conditions, large roll angles can be experienced within a short period of time limiting the amount of preventative action the master can take.

As such, if there are parametric avoidance tools to assist the master, these should be used to support the onboard decision-making process.

Large roll motion of the vessel is the main cause of container loss.

Why are large container ships vulnerable?

Fine hull forms with pronounced bow flare and flat transom stern are most vulnerable to parametric roll. Such features contribute to the variation of the ship's stability characteristics due to the constant change of the underwater hull geometry as waves travel past the ship.

Although this phenomenon has been studied in the past, it has only come to prominence with the introduction of the larger container ships. Until the 1990s, it was considered critical only for ships with marginal stability and fine-lined warships.

Consequences of a parametric roll

Parametric roll can have dire consequences for container securing and for operation of machinery.

It is an extreme condition for container securing since it combines the effect of large roll and pitch amplitudes. This scenario imposes significant loads on container securing systems.

If the container securing system considers such extreme motions, there would be a significant reduction in the number of containers that could be carried on deck. So good seamanship is essential to avoid parametric rolling as much as possible via timely course or ship speed alterations.

The extreme roll angles reached during a parametric roll usually exceed those adopted during machinery design. Indeed, it would be very difficult to bench test a large marine diesel engine at 40-degree angles. Possible consequences on machinery operation of the ship heeling to these very large angles include loss of cooling water suction, exposure of lubricating oil sumps and, for resiliently mounted engines, problems

with the connection of services and hence shutdown of the main engine.

The following points should be borne in mind:

- Parametric roll is a relatively rare phenomenon, occurring in head or following seas, which is characterised by rapidly developed, large, unstable ship rolling.
- Risk control options exist in both design and operation of container ships that can effectively reduce the likelihood of a parametric roll occurring. Reducing the likelihood of its occurrence is considered a more effective approach than mitigating the consequences.
- Compliance with Lloyd's Register's current requirements for container securing systems can reduce the risk of container losses.
- Masters should be aware that when conditions for parametric rolling exist, i.e. head/stern seas with wave length similar to the ship's length, the action of putting the ship's head to the sea and reducing speed could make rolling worse. Alternative action to ease the ship's motion will be necessary, depending upon the prevailing weather.
- The North Pacific in winter is especially prone to these conditions.

Very large container ships

With a very large container ship of up to 24,000 TEU, the master has better control over the roll motion when the ship has a lower GM. The roll angle experienced on these ships is generally lower than that for smaller ships.

But when it comes to parametric rolling, these very large container ships are not immune, and can succumb to parametric rolling in longer and bigger waves.

Extreme roll angles can result in a very high level of container losses for these ships. Stack interaction can have a domino effect, causing the loss of a whole bay.

It therefore becomes vital that on very large vessels which may have untouched stacks for a prolonged period of time due to port rotation, the lashings are regularly checked and tightened by the ship's crew. Although the individual number of cases of container deck losses may have reduced, the magnitude of losses has increased and has become more severe.



Figure 42: Outboard container damaged by adverse weather and incorrect stowage

12. Consequences of failure – case study

The consequences of failure are almost always loss, or damage to containers. The club has been involved in every type of incident following container loss, from widespread pollution after a floating container hit a ship's hull and pierced a fuel tank, to wreck removal of sunken containers containing toxic chemicals, to a seaman hit by cargo falling from an open container. The study that follows graphically illustrates how simple faults, even on a well-run ship, can give rise to large container losses and the incidents described above.

It was February and the Panamax container ship had loaded in Northern hemisphere ports for China. She had seven holds and could carry more than 3,000 containers, although less had been loaded on this occasion. Loading was homogeneous, without isolated stacks, but the heights of the containers differed. The containers were loaded on the deck, five high in some bays and three high in others. The lashings consisted of base (manual) twistlocks fitted into dovetail foundations, with semi-automatic twistlocks used between containers. Parallel cross-lashings were applied using short and long lashing rods with turnbuckles. These connected to the top corner of the first tier containers and the bottom corner of the second tier containers. Wind lashings were applied on the outboard stacks, with long rods connected to the bottom corner of the third tier containers. The ship's GM was 2.0m.

The schedule required sailing south along the western seaboard of the United States before crossing the Pacific to Japan and China. The ship was on a southerly course when she encountered strong head winds with heavy head seas and swell. She was pitching and rolling heavily with occasional rolls to very large angles when a loud crash was heard. It was suspected that containers had been lost or had shifted. The next morning, the extent of the damage could be seen. The entire stack forward of the bridge had collapsed. Many containers remained on board, but some had fallen overboard. Investigations revealed that a few classic mistakes had contributed to the loss.



Figure 43: Damaged container showing corner post compression

Course and speed

The ship was proceeding on a southerly course into head seas and was pitching and rolling heavily. Rolling in head seas may be associated with the phenomenon known as ‘parametric rolling’, which occurs because the ship’s waterplane area changes as waves pass along the ship’s length. Maximum rolling can occur when a wave’s length is comparable to the ship’s length. At the instant when the ship’s midship is supported by a wave crest, and the bow and stern are in a wave trough, there is an instantaneous loss of waterplane, a sudden and massive loss of righting force, and the ship may roll to very large angles. As the wave passes along the ship’s length, the situation is reversed, strong righting forces are exerted and the ship rights herself only to roll again as the next wave passes. Effectively, the ship performs simple harmonic motion but with violent rolling.

During the conditions of very severe rolling, containers stowed on deck can be subjected to massive separation forces, forces that are likely to exceed the combined strength of the securing system. Parametric rolling may be prevented by altering course or changing speed.

Stowage and securing

The bottom container in each stack was secured by twistlocks fitted to dovetail sockets which slide into dovetail foundations. Dovetail foundations, for a variety of reasons, tend to wear, which can result in movement of the securing twistlock. In extreme circumstances, the base twistlock can be pulled out of the dovetail foundation, leaving only the lashing rods to hold the containers in place, something which they are not designed to do. This had happened and, as a consequence, the turnbuckle had pulled apart and the lashing rods had broken.

One end of the lashing rod was connected to a D ring and D rings were welded to the lashing bridge for this purpose. Some of the D rings had been pulled apart and it was found that the D ring securing collars had been poorly welded and were weak. Quality of welding is a matter for new build superintendents, not the ship’s crew, but during routine maintenance, chipping and painting, welds that connect securing points to the ship should be examined for corrosion, damage or defect, with any observed deficiency being reported to the master. On this ship, the D ring collar welds had very poor penetration and the securing point was weak.

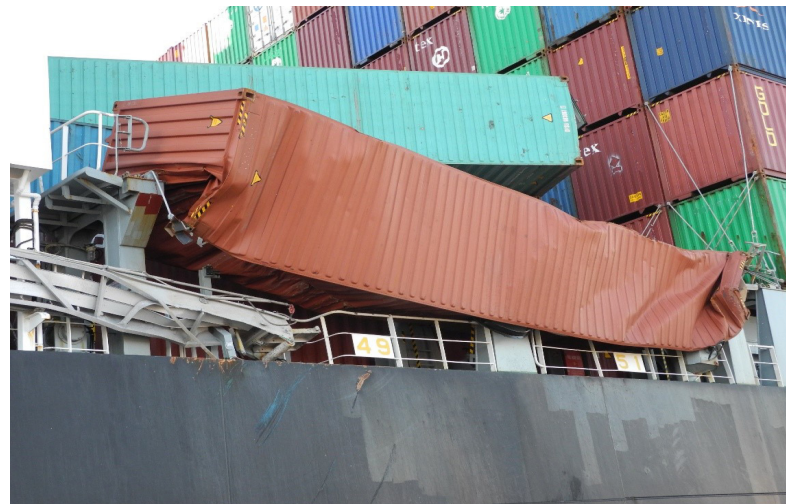

Figure 44: Lashing failure causing container loss due to adverse weather and incorrect stow

This is not something a ship’s crew can correct, but an observant seaman who spots a defect and reports it can be instrumental in preventing a major loss. The base foundations need regular examination and testing, something which should form part of the ship’s planned maintenance procedure.

Ship behaviour continued

Not all the base twistlocks had failed, some were found unlocked and it was suspected that the ship had been using left-hand and right-hand locks in the same stow. Using left-hand and right-hand locks in the same stow makes it very difficult to detect whether a twistlock is locked or open. Ship's crew should check for incorrectly handed locks and remove them.

The ship had been loaded in accordance with the limits imposed by class and nothing improper was found with the container distribution or stack weights. However, mathematical simulation of the forces imposed on the containers during violent rolling indicated that the racking and compression forces on the containers exceeded the design strength of the lashings by 1.5 and 2.5 times respectively. This would have resulted in very large separation forces on the stacked containers. Prior to the incident, the crew had checked that the

turnbuckles were evenly tightened, but they had not applied additional wind lashings. Any additional lashings applied in exposed locations before the onset of severe roll and pitch conditions should improve combined lashing strength, provided the lashings are applied to the bottoms or tops of containers that are only secured by twistlocks.

With the benefit of hindsight, it is possible to see how simple errors can cause container loss. The weather conditions experienced were not extreme, but the effects of parametric rolling, worn base foundations and weak D-ring collars all contributed to the catastrophic loss of containers. It is rarely a single failure that results in a loss but a sequence of events. For this reason, it is essential to follow best practice and the principles set out in this guide.



Figure 45: Failed twistlock

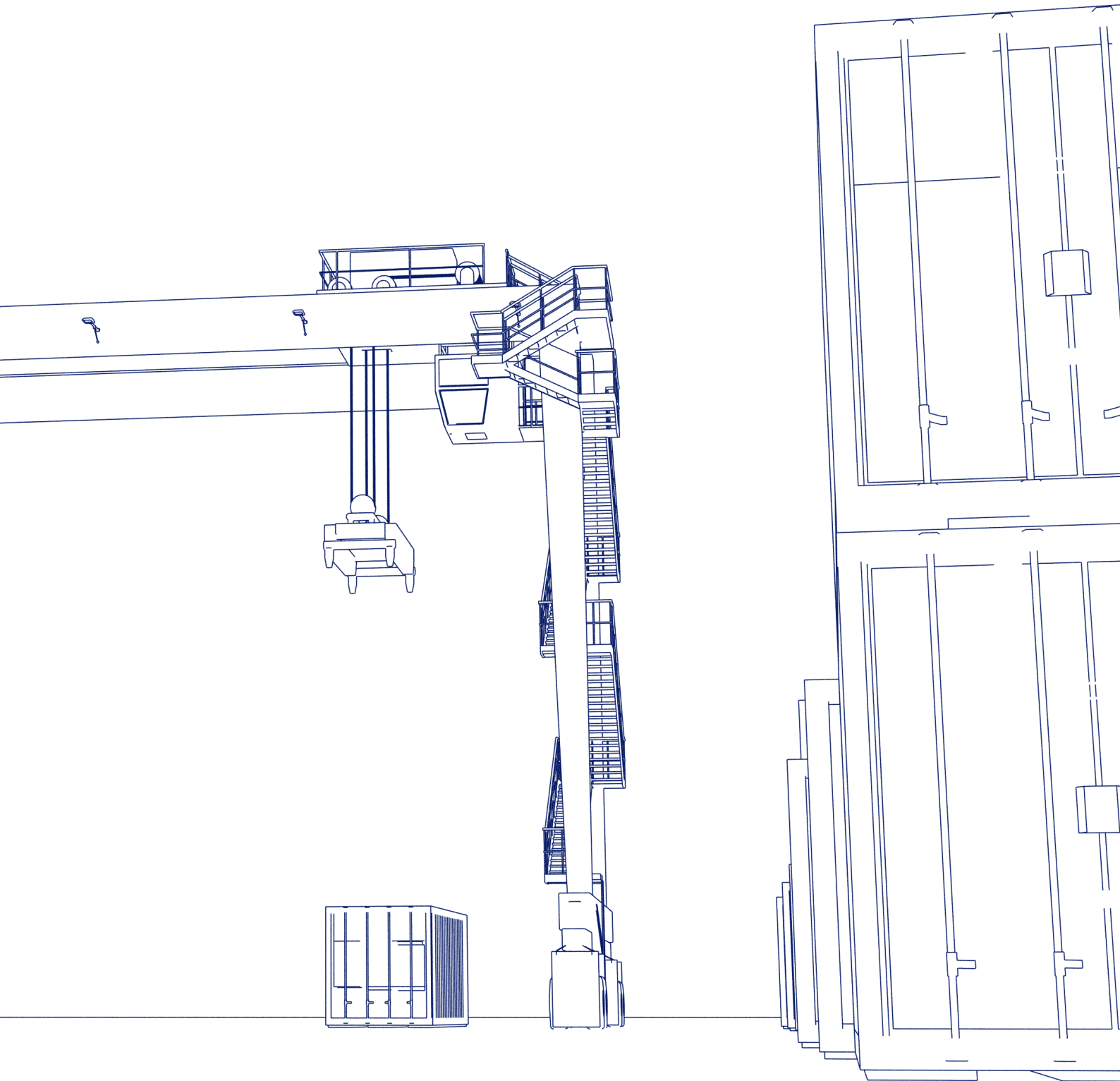

List of photos and diagrams

Figure 1: Six degrees of a ship's motion	4
Figure 2: Ship alongside discharging containers	5
Figure 3: Application of outboard lashings	13
Figure 4: Crew member clearing lashing equipment from work area	13
Figure 5: Cellular container ship	14
Figure 6: Hatchless container ship	14
Figure 7: Typical arrangement for con-bulker with gantry crane	14
Figure 8: Ro-Ro cargo ship with containers on deck	15
Figure 9: Multipurpose general cargo ship with capacity to carry containers on deck	15
Figure 10: Lloyds' Register of Ships and Rules & Regulations for the Classification of Ships.	15
Figure 11: CSC plate	16
Figure 12: Do not lash to the overhanging end of a 45ft container	17
Figure 13: 40ft dry van box containers	18
Figure 14: Reefer unit	18
Figure 15: Typical arrangement for a tank container	19
Figure 16: Two flat racks	19
Figure 17: Corner casting arrangement for a Euro container	19
Figure 18: Container test rig	20
Figure 19: Container construction and faults	21
Figure 20: Lloyd's Register logo	22
Figure 21: List of lashing components	24
Figure 22: List of portable lashing equipment	25
Figure 23: List of portable lashing equipment	26
Figure 24: List of portable lashing equipment	27
Figure 25: Lashing components	28
Figure 26: Lashing components	29
Figure 27: Assorted twistlocks	30
Figure 28: Securing with parallel lashing rods and semi-automatic twistlocks	31
Figure 29: 40ft containers in 40ft cell guides	32
Figure 30: 20ft containers in 40ft cell guides with 40ft containers stowed above.	33
Figure 31: 20ft containers stowed in 40ft cell guides with overstow, diagonal stacking cone arrangement	33
Figure 32: Typical bulk carrier stowage arrangement with buttresses, using single/double stacking cones and bridge fittings	34
Figure 33: Containers secured by twistlocks. Usually for two tiers only.	35
Figure 34: Containers secured by twistlocks and lashing rods. Lashing rods to bottom of second tier. Wind lashings to bottom of third tier.	35
Figure 35: Containers secured by twistlocks and lashing rods. Lashing rods to bottom of third tier	35
Figure 36: Container secured by twistlocks and lashing rods. 'External lashing' arrangement	36
Figure 37: As for Figure 36 above but lashings originate from lashing bridge. Lashing rods to bottom of fifth tier	36

Figure 38: Transport of 40ft container.	38
Figure 39: FATs removed and fitted ashore	39
Figure 40: Container ship operator must know the ship's design roll angle	40
Figure 41: Forces on 20ft and 40ft containers	41
Figure 42: Outboard container damaged by adverse weather and incorrect stowage	43
Figure 43: Damaged container showing corner post compression	44
Figure 44: Lashing failure causing container loss due to adverse weather and incorrect stow	45
Figure 45: Failed twistlock	46

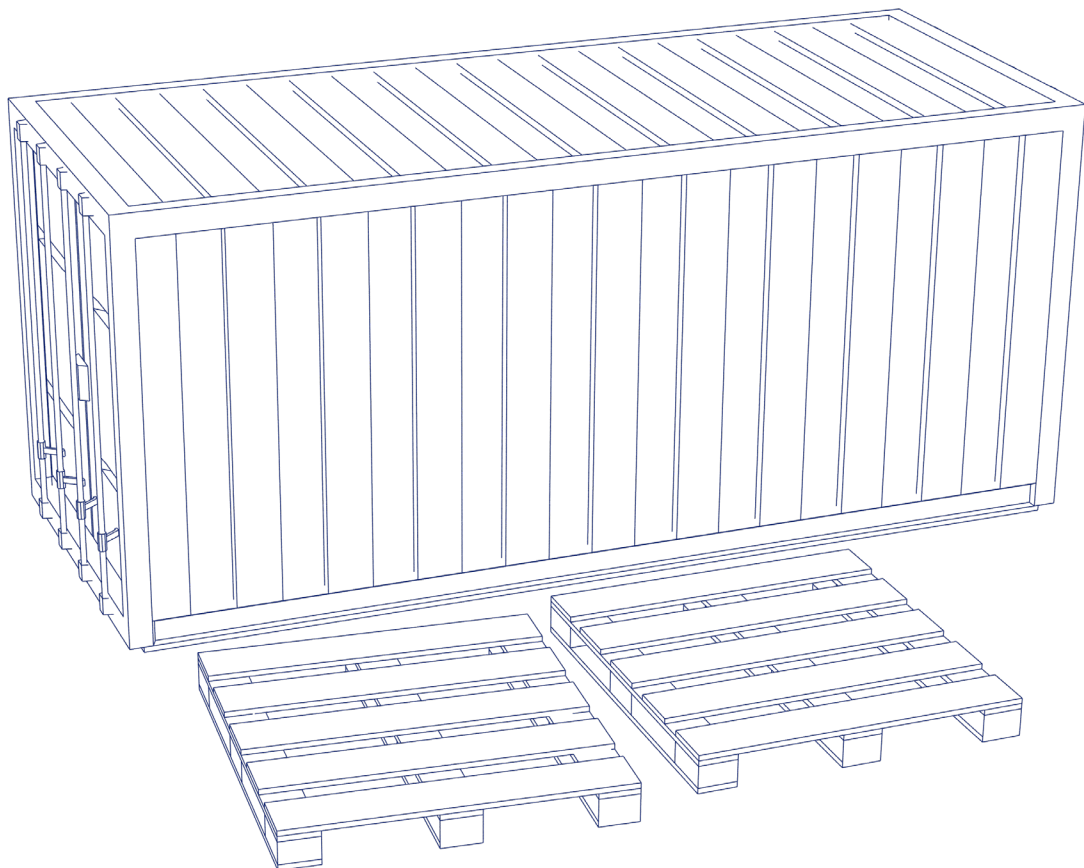

Authors

Kirk McGregor, Senior Surveyor

Captain Robert Kirk McGregor is a master mariner, having spent over 20 years at sea, serving as master on feeder container ships. He has experience as a flag state surveyor and has previously worked as a master mariner expert attending container ships that have incurred deck container collapses and losses. Kirk is a senior surveyor with the club's loss prevention department.



Seb Brindley, Lead Specialist

Seb Brindley is the product owner for Lloyd's Register's BoxMax notation and responsible for the development of Lloyd's Register's Container Securing Rules and its software, LashRight. He has coordinated the development of LR's advanced stack assessment procedure suitable for ultra large container carriers and LR's BoxMax(M) notation; aimed at developing a safer and transparent process for optimised container operation.



The authors acknowledge technical contributions from colleagues and associates with particular thanks to:

- Eric Murdoch BSc, MSc, CEng, MRINA, MI MarEST
- David Tozer BSc, MSc, CEng, FRINA, FI MechE, of Lloyd's Register
- Manuel Ortuño, Surveyor, Lloyd's Register EMEA, Hamburg
- Roy Smith, Training Instructor (operations), Hutchinson Ports (UK)

Keep up to date by visiting the Knowledge Centre section on our website [standard-club.com](https://www.standard-club.com)

 **@StandardPandi**
in The Standard P&I Club

The Standard Club Ltd is incorporated in Bermuda (No. 01837), authorised and regulated by the Bermuda Monetary Authority. Registered office: Swan Building, 2nd Floor, 26 Victoria Street, Hamilton HM 12. The Standard Club Ltd is the holding company of The Standard Club UK Ltd, The Standard Club Ireland DAC (both managed by Charles Taylor & Co. Limited) and The Standard Club Asia Ltd (managed by Charles Taylor Mutual Management (Asia) Pte. Limited).

The Standard Club UK Ltd is registered in England, No.17864, at The Minster Building, 21 Mincing Lane, London EC3R 7AG, authorised by the Prudential Regulation Authority FRN 202805 and is regulated by the Financial Conduct Authority and the Prudential Regulation Authority. The Standard Club Ireland DAC is registered in Ireland, No. 631911, at Fitzwilliam Hall, Fitzwilliam Place, Dublin 2; authorised and regulated by the Central Bank of Ireland. Managers: Charles Taylor & Co. Limited. Registered in England No. 02561548 is authorised and regulated by the Financial Conduct Authority FRN 785106. Registered office: The Minster Building, 21 Mincing Lane, London EC3R 7AG.

The Standard Club Asia Ltd. is a company incorporated in Singapore with limited liability (No. 199703224R), authorised and regulated by the Monetary Authority of Singapore. Managers: Charles Taylor Mutual Management (Asia) Pte. Limited, a company incorporated in Singapore with limited liability (No. 199703244C). Registered office: 140 Cecil Street, #15-00 PIL Building, Singapore 069540. The Standard Club Asia Ltd (Hong Kong Branch) is authorised and regulated by the Hong Kong Insurance Authority, registered in Hong Kong (No. F24636). Managers: Charles Taylor Mutual Management (Asia) Pte. Limited (Hong Kong Branch), registered in Hong Kong (No. F24645). Registered offices: Suite A, 29/F 633 King's Road, Quarry Bay, Hong Kong.

Managed by
 **Charles
Taylor**