

UNITED NATIONS ECONOMIC COMMISSION FOR EUROPE
INLAND TRANSPORT COMMITTEE
Working Party on Inland Water Transport

CEVNI

European Code for Inland Waterways

Fifth revised edition

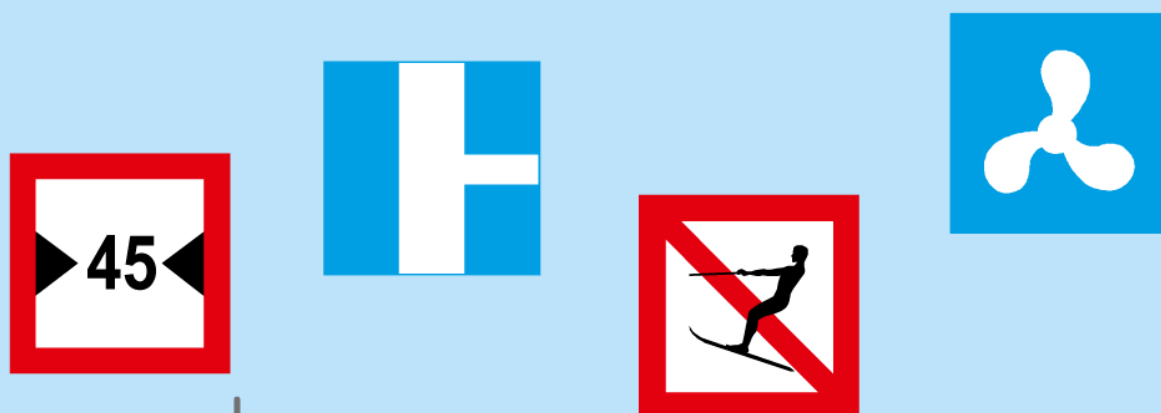

UNITED NATIONS

NOTE

Symbols of United Nations documents are composed of capital letters combined with figures. Mention of such a symbol indicates a reference to a United Nations document.

*

*

*

The designations employed and the presentation of the material in this publication do not imply the expression of any opinion whatsoever on the part of the Secretariat of the United Nations concerning the legal status of any country, territory, city or area, or of its authorities, or concerning the delimitation of its frontiers or boundaries.

| |
|--------------------------|
| ECE/TRANS/SC.3/115/Rev.5 |
|--------------------------|

| |
|----------------------------|
| UNITED NATIONS PUBLICATION |
|----------------------------|

| |
|----------------------|
| Sales No.: 15.II.E.8 |
|----------------------|

| |
|------------------------|
| ISBN 978-92-1-117090-0 |
|------------------------|

UNITED NATIONS ECONOMIC COMMISSION FOR EUROPE

The United Nations Economic Commission for Europe (UNECE) is one of the five United Nations regional commissions, administered by the Economic and Social Council (ECOSOC). It was established in 1947 with the mandate to help rebuild post-war Europe, develop economic activity and strengthen economic relations among European countries, and between Europe and the rest of the world. During the Cold War, UNECE served as a unique forum for economic dialogue and cooperation between East and West. Despite the complexity of this period, significant achievements were made, with consensus reached on numerous harmonization and standardization agreements.

In the post-Cold War era, UNECE acquired not only many new member States, but also new functions. Since the early 1990s the organization has focused on analyses of the transition process, using its harmonization experience to facilitate the integration of Central and Eastern European countries into the global markets.

UNECE is the forum where the countries of western, central and eastern Europe, central Asia and North America – 56 countries in all – come together to forge the tools of their economic cooperation. That cooperation concerns economics, statistics, environment, transport, trade, sustainable energy, timber and habitat. The Commission offers a regional framework for the elaboration and harmonization of conventions, norms and standards. The Commission's experts provide technical assistance to the countries of South-East Europe and the Commonwealth of Independent States. This assistance takes the form of advisory services, training seminars and workshops where countries can share their experiences and best practices.

TRANSPORT IN UNECE

The UNECE Transport Division is the secretariat of the Inland Transport Committee (ITC) and the ECOSOC Committee of Experts on the Transport of Dangerous Goods and on the Globally Harmonized System of Classification and Labelling of Chemicals. The ITC and its 17 working parties, as well as the ECOSOC Committee and its sub-committees are intergovernmental decision-making bodies that work to improve the daily lives of people and businesses around the world in measurable ways and with concrete actions that enhance traffic safety, environmental performance, energy efficiency and the competitiveness of the transport sector.

The *ECOSOC Committee* was set up in 1953 by the Secretary-General at the request of the Economic and Social Council to elaborate recommendations on the transport of dangerous goods. Its mandate was extended to the global (multisectoral) harmonization of systems of classification and labelling of chemicals in 1999. It is composed of experts from countries which possess the relevant expertise and experience in the international trade and transport of dangerous goods and chemicals. Its membership is restricted in order to reflect a proper geographical balance between all regions of the world and to ensure adequate participation of developing countries. Although the Committee is a subsidiary body of ECOSOC, the Secretary-General decided in 1963 that the secretariat services would be provided by the UNECE Transport Division.

The *Inland Transport Committee* is a unique intergovernmental forum that was set up in 1947 to support the reconstruction of transport connections in post-war Europe. Over the years it has specialized in facilitating the harmonized and sustainable development of inland modes of transport. The main results of this persevering and ongoing work are reflected among other things (i) in 58 United Nations conventions and many more technical regulations which are updated on a regular basis and provide an international legal framework for the sustainable development of national and international road, rail, inland water and intermodal transport, as well as the transport of dangerous goods and the construction and inspection of road motor vehicles; (ii) in the Trans-European Motorways, Trans-European Railways and the Euro-Asia Transport Links projects that facilitate multi-country coordination of transport infrastructure investment programmes; (iii) in the TIR system which is a global customs transit facilitation solution; (iv) in the tool called

For Future Inland Transport Systems (ForFITS) which can assist national and local governments to monitor CO₂ emissions coming from inland transport modes and to select and design climate change mitigation policies based on their impact and adapted to local conditions; (v) in transport statistics – methods and data – that are internationally agreed on; (vi) in studies and reports that help transport policy development by addressing timely issues based on cutting-edge research and analysis. ITC also devotes special attention to Intelligent Transport Services, sustainable urban mobility and city logistics, as well as to increasing the resilience of transport networks and services in response to climate change adaptation and security challenges.

CEVNI EUROPEAN CODE FOR INLAND WATERWAYS FIFTH REVISED EDITION

Activities focused on developing standards and conventions in inland waterways started following the creation of the Sub-Committee on Inland Water Transport by the Inland Transport Committee of the United Nations Economic Commission for Europe (UNECE) at its 16th session in December 1956. The aim of the Sub-Committee was to consider questions relating to inland water transport together with the Working Party on River Law with the primary task being to prepare the two draft conventions, one on the unification of certain rules concerning collision in inland navigation and one on the registration of inland navigation vessels. At the time, it was acknowledged that harmonised navigation rules were essential to facilitate traffic on inland waterways and to ensure safety; this Sub-Committee has, since then, been the guardian of these rules. The Sub-Committee on Inland Water Transport (which was subsequently transformed into the Working Party on Inland Water Transport — SC.3 — of the Inland Transport Committee), had as its main agenda items: development of unified system of inland waterways and development of European inland waterway network, the development of a European Code for Inland Waterways, harmonization of police regulations and technical prescriptions for vessels, standardization of vessel documents; all of which were developed through international agreements and resolutions within the Working Party.

The European Code for Inland Waterways (CEVNI) was first established in 1962, following approval by the aforementioned Sub-Committee on Inland Water Transport. With this fifth edition, the Working Party on Inland Water Transport and its expert group on CEVNI have taken into account best practices from the existing traffic regulations of the river commissions and UNECE member States. In particular, this revision updates several articles in relation to small craft, radiotelephony, Inland Automatic Identification System (AIS), prevention of pollution of water and an annex on safety checklist for bunkering fuel is added.

This fifth edition of CEVNI represents the revised text of the annex to Resolution No. 24 which replaces the previous text that was amended in accordance to resolutions Nos. 26, 27, 37, 39, 43 to 47, 54, 62 and 66. This replacement has been decided through Resolution No. 81, adopted by the Working Party on Inland Water Transport at its 58th session (ECE/TRANS/SC.3/197), in accordance with the approval procedure established since the adoption of the original Resolution in 1985. It has been prepared thanks to the work of the group of experts at its meetings between 2010 and 2014.

CEVNI – European Code for Inland Waterways

Resolution No. 24

Adopted on 15 November 1985 by the Working Party on Inland Water Transport

The Working Party on Inland Water Transport,

Having regard to resolution No. 4 of the Sub-Committee on Inland Water Transport (TRANS/270, annex 1) concerning the application of the European Inland Waterway Navigation Code (CEVNI), and to the amended text of CEVNI reproduced in document W/TRANS/SC.3/37/Rev.2, which takes into account the Sub-Committee's resolutions Nos. 7 and 8 and its report TRANS/333, annex 1,

Noting that amendments concerning navigation on lakes and concerning navigation on rivers, in particular for small craft, have been added to CEVNI by resolutions Nos. 19 and 20 respectively (TRANS/SC.3/91, annex 1 and TRANS/SC.3/95),

Noting that, through the application of the recommendations of these resolutions by Governments and river commissions, the corresponding regulations in force on European inland waterways have to a large extent been harmonized,

Noting the increase in traffic on inland waterways and, *inter alia*, the development of sea river transport and of modern techniques in navigation,

Noting the desirability, in the interest of safety in navigation, of taking into account in CEVNI developments in inland navigation and their consequences for the regulations in force,

Noting further the desirability of incorporating the special provisions concerning navigation on lakes and the rules of the road for small craft in the relevant parts of CEVNI,

Having considered the request by the Inland Transport Committee that CEVNI should be revised (W/TRANS/SC.3/37/Rev.2) (ECE/TRANS/23, para. 115),

Decides to replace the text of CEVNI, as reproduced in document W/TRANS/SC.3/37/Rev.2, and the amendments thereto reproduced in documents TRANS/SC.3/91, annex 1 and TRANS/SC.3/95, by the annex to this resolution, entitled "CEVNI: European Code for Inland Waterways", which is reproduced in document TRANS/SC.3/115,

Decides to formulate annexes 9, 10 and 11 after the revision of the European Provisions concerning the International Carriage of Dangerous Goods by Inland Waterway (ADN) (resolution No. 223 of the Inland Transport Committee),

Reiterates its recommendation addressed in resolution No. 4 to Governments and River Commissions to undertake, on the basis of the recommendations in paragraphs 1 and 2 below, the revision of regulations in force on inland waterways,

1. National regulations should consist of two parts:

- (a) The first part should embody the provisions contained in the annex to this resolution under the title "CEVNI: European Code for Inland Waterways".

In reproducing these provisions, it is most desirable to maintain the existing order and numbering of the chapters and, so far as possible, the existing order, titles and wording of the articles themselves, but

- i) In cases where CEVNI provides for several possibilities, not all of those possibilities need be included in the national regulations;
- ii) Governments may omit, complement or modify certain provisions of Chapters 1–8 of CEVNI, when this is required by the conditions of navigation. The list of such provisions is contained in Chapter 9 on "Regional and National Special Requirements". In this case, Governments shall report on these differences to the Working Party on Inland Water Transport (SC.3);

- (b) The second part should contain the specific provisions which Governments consider necessary in view of local conditions. These specific provisions should not be at variance with the provisions of CEVNI, including any which may not have been reproduced in the first part. Further, with regard to matters to which the provisions of CEVNI apply, and particularly, to the marking of vessels, Governments should not, in the absence of very special local conditions, impose any obligations which are not contained in CEVNI itself;

2. In every country, the first part of the regulations should, if possible, be the same for all the inland waterways of the country concerned; nevertheless, a Government may depart from this rule if the special characteristics of the various inland waterway networks in the country concerned are so different that it cannot be applied;

Requests Governments and River Commissions to inform the Executive Secretary of the Economic Commission for Europe by 1 July 1987 whether they can implement this resolution,

Requests the Executive Secretary of the Economic Commission for Europe to place the question of the application of this resolution periodically on the agenda of the Working Party on Inland Water Transport.

CONTENTS

| | <u>Page</u> |
|--|-------------|
| Resolution No. 24 - European Code for Inland Waterways (CEVNI)..... | vii |
| Annex to Resolution No. 24 | 1 |
| Chapter 1 GENERAL PROVISIONS..... | 1 |
| Article 1.01 – Meaning of certain terms | 1 |
| I. TYPES OF VESSELS | 1 |
| II. CONVOYS | 2 |
| III. LIGHT AND SOUND SIGNALS..... | 3 |
| IV. OTHER TERMS | 3 |
| Article 1.02 – Boatmaster | 5 |
| Article 1.03 – Duties of crew and other persons on board | 6 |
| Article 1.04 – General obligation to exercise vigilance | 6 |
| Article 1.05 – Conduct in special circumstances | 7 |
| Article 1.06 – Use of the waterway | 7 |
| Article 1.07 – Maximum load, maximum number of passengers and view | 7 |
| Article 1.08 – Construction, rigging and crews of vessels | 8 |
| Article 1.09 – Steering | 8 |
| Article 1.10 – Vessel’s papers and other documents..... | 9 |
| Article 1.11 – Navigation regulations..... | 10 |
| Article 1.12 – Dangerous objects on board; loss of objects; obstacles | 10 |
| Article 1.13 – Protection of waterway signs and marking | 10 |
| Article 1.14 – Damage to permanent structures | 11 |
| Article 1.15 – Prohibition of discharge into the waterways..... | 11 |
| Article 1.16 – Salvage and assistance | 11 |
| Article 1.17 – Grounded or sunken vessels..... | 11 |
| Article 1.18 – Obligation to clear the fairway..... | 12 |
| Article 1.19 – Special instructions | 12 |
| Article 1.20 – Inspection..... | 12 |
| Article 1.21 – Special transport operations..... | 13 |
| Article 1.22 – Special temporary requirements | 13 |
| Article 1.23 – Authorization of public events | 13 |
| Article 1.24 – Applicability in ports, loading and unloading zones..... | 13 |
| Chapter 2 MARKS AND DRAUGHT SCALES ON VESSELS; TONNAGE MEASUREMENT..... | 15 |
| Article 2.01 – Identification marks on vessels other than small craft and seagoing vessels..... | 15 |
| Article 2.02 – Identification marks on small craft | 16 |
| Article 2.03 – Tonnage measurement..... | 17 |
| Article 2.04 – Draught marks and draught scales..... | 17 |

CONTENTS (continued)

| | |
|--|-----------|
| Article 3.29 – Additional marking for protection against wash..... | 37 |
| Article 3.30 – Distress signals | 37 |
| Article 3.31 – Prohibition of boarding | 38 |
| Article 3.32 – Prohibition of smoking or using fires and naked light | 38 |
| Article 3.33 – Prohibition of lateral berthing | 39 |
| Article 3.34 – Additional marking for vessels whose ability to manoeuvre is limited..... | 39 |
| Article 3.35 – Additional marking for vessels engaged in fishing | 40 |
| Article 3.36 – Additional marking for vessels used for underwater diving | 41 |
| Article 3.37 – Additional marking for vessels engaged in minesweeping..... | 41 |
| Article 3.38 – Additional marking for vessels on pilotage service..... | 42 |
| Chapter 4 SOUND SIGNALS; RADIOTELEPHONY; navigation devices | 43 |
| Article 4.01 – General | 43 |
| Article 4.02 – Use of sound signals | 44 |
| Article 4.03 – Prohibited sound signals | 44 |
| Article 4.04 – Distress signals | 44 |
| Article 4.05 – Radiotelephony..... | 44 |
| Article 4.06 – Radar | 45 |
| Article 4.07 – Inland Automatic Identification System (AIS) | 46 |
| Chapter 5 WATERWAY SIGNS AND MARKING | 49 |
| Article 5.01 – Signs | 49 |
| Article 5.02 – Marking | 49 |
| Chapter 6 RULES OF THE ROAD | 51 |
| I. GENERAL | 51 |
| Article 6.01 – Definitions and scope of application | 51 |
| Article 6.01 bis – High-speed vessels | 51 |
| Article 6.02 – Small craft: General rules | 51 |
| II. MEETING, CROSSING AND OVERTAKING | 52 |
| Article 6.03 – General principles | 52 |
| Article 6.03 bis – Crossing | 52 |
| Article 6.04 – Meeting: Normal rules | 53 |
| Article 6.05 – Meeting: Departures from normal rules | 54 |
| Article 6.06 – Meeting: High speed vessels | 55 |
| Article 6.07 – Meeting in narrow fairways | 55 |
| Article 6.08 – Meeting prohibited by waterway signs | 56 |
| Article 6.09 – Overtaking: General provisions..... | 57 |
| Article 6.10 – Overtaking..... | 57 |
| Article 6.11 – Overtaking prohibited by waterway signs..... | 58 |

CONTENTS (continued)

| | |
|---|----|
| III. OTHER RULES OF THE ROAD | 58 |
| Article 6.12 – Navigation on sections where the course is prescribed..... | 58 |
| Article 6.13 – Turning | 59 |
| Article 6.14 – Procedure on departure | 59 |
| Article 6.15 – Prohibition of entering the spaces between vessels in a towed convoy | 59 |
| Article 6.16 – Harbours and tributary waterways: entering and leaving; leaving followed by crossing the waterway | 60 |
| Article 6.17 – Sailing abreast and prohibition to approach vessels..... | 61 |
| Article 6.18 – Prohibition of trailing of anchors, cables or chains | 61 |
| Article 6.19 – Drifting..... | 62 |
| Article 6.20 – Wash | 62 |
| Article 6.21 – Convoys | 62 |
| Article 6.21 bis – Relocation of pushed barges outside a pushed convoy | 63 |
| Article 6.22 – Suspension of navigation | 63 |
| Article 6.22 bis – Navigation when passing floating equipment at work or grounded or sunken vessels, and vessels whose ability to manoeuvre is limited..... | 63 |
| IV. FERRY-BOATS..... | 64 |
| Article 6.23 – Rules applicable to ferry-boats | 64 |
| V. PASSAGE UNDER BRIDGES AND THROUGH WEIRS AND LOCKS | 64 |
| Article 6.24 – Passage under bridges and through weirs: General | 64 |
| Article 6.25 – Passage under fixed bridges..... | 65 |
| Article 6.26 – Passage through movable bridges..... | 65 |
| Article 6.27 – Passage through weirs..... | 66 |
| Article 6.28 – Passage through locks | 67 |
| Article 6.28 bis – Entering and leaving locks | 68 |
| Article 6.29 – Priority of passage through locks | 69 |
| VI. REDUCED VISIBILITY – NAVIGATION BY RADAR..... | 70 |
| Article 6.30 – General rules for navigation in reduced visibility; navigation by radar..... | 70 |
| Article 6.31 – Sound signals when stationary | 70 |
| Article 6.32 – Navigation by radar | 71 |
| Article 6.33 – Provisions for vessels not navigating by radar | 72 |
| VII. SPECIAL RULES | 72 |
| Article 6.34 – Special priorities..... | 72 |
| Article 6.35 – Water skiing and similar activities..... | 73 |
| Article 6.36 – Conduct of, and in respect of, fishing vessels | 73 |
| Article 6.37 – Conduct of, and in respect of, underwater divers | 73 |
| Chapter 7 BERTHING RULES..... | 75 |
| Article 7.01 – General principles of berthing..... | 75 |

CONTENTS (continued)

| | |
|---|-----------|
| Article 7.02 – Berthing | 75 |
| Article 7.03 – Anchoring and use of telescopic piles (spuds) | 76 |
| Article 7.04 – Making fast | 77 |
| Article 7.05 – Berthing areas..... | 77 |
| Article 7.06 – Berthing authorized for certain types of vessels..... | 77 |
| Article 7.07 – Berthing in case of transport operations involving dangerous substances..... | 78 |
| Article 7.08 – Watch and surveillance..... | 78 |
| Chapter 8 SIGNALLING AND REPORTING REQUIREMENTS | 79 |
| Article 8.01 – “Do not approach” signal | 79 |
| Article 8.02 – Reporting requirements..... | 80 |
| Chapter 9 REGIONAL AND NATIONAL SPECIAL REQUIREMENTS..... | 83 |
| Article 9.01 – Regional and national special requirements..... | 83 |
| Article 9.02 – Chapter 1, “GENERAL PROVISIONS” | 83 |
| Article 9.03 – Chapter 2, “MARKS AND DRAUGHT SCALES ON VESSELS; TONNAGE MEASUREMENT” | 84 |
| Article 9.04 – Chapter 3, “VISUAL SIGNALS (MARKING) ON VESSELS” | 85 |
| Article 9.05 – Chapter 4, “SOUND SIGNALS; RADIOTELEPHONY; NAVIGATION DEVICES” | 86 |
| Article 9.06 – Chapter 5, “WATERWAY SIGNS AND MARKING” | 86 |
| Article 9.07 – Chapter 6, “RULES OF THE ROAD” | 86 |
| Article 9.08 – Chapter 7, “BERTHING RULES” | 87 |
| Article 9.09 – Chapter 8, “SIGNALLING AND REPORTING REQUIREMENTS” | 87 |
| Chapter 10 PREVENTION OF POLLUTION OF WATER AND DISPOSAL OF WASTE GENERATED ON BOARD VESSELS | 89 |
| Article 10.01 – Meaning of certain terms | 89 |
| Article 10.02 – Obligation to observe regional requirements..... | 90 |
| Article 10.03 – General obligation to exercise vigilance | 91 |
| Article 10.04 – Prohibition on discharging and dumping..... | 91 |
| Article 10.05 – On board collection and processing of waste..... | 91 |
| Article 10.06 – Used-oil log, deposit at reception facilities..... | 92 |
| Article 10.07 – Obligation to exercise vigilance during filling operations..... | 92 |
| Article 10.08 – Collection, deposit and reception of cargo-related waste | 93 |
| Article 10.09 – Painting and external cleaning of vessels | 94 |

CONTENTS *(continued)*

| | | |
|---------|--|-----|
| Annex 1 | DISTINGUISHING LETTER OR GROUP OF LETTERS INDICATING COUNTRY OF VESSELS' HOME PORT OR PLACE OF REGISTRATION.... | 95 |
| Annex 2 | DRAUGHT SCALES ON INLAND WATERWAY VESSELS | 97 |
| Annex 3 | VISUAL SIGNALS (MARKING) ON VESSELS | 99 |
| | I. GENERAL | 99 |
| | II. MARKING WHEN UNDER WAY | 101 |
| | III. MARKING WHEN STATIONARY | 114 |
| | IV. SPECIAL MARKING | 120 |
| Annex 4 | LIGHTS AND THE COLOUR OF SIGNAL LIGHTS ON VESSELS | 125 |
| Annex 5 | INTENSITY AND RANGE OF SIGNAL LIGHTS ON VESSELS | 127 |
| Annex 6 | SOUND SIGNALS | 129 |
| | I. SOUND INTENSITY OF SIGNALS..... | 129 |
| | II. MONITORING OF SOUND PRESSURE LEVEL..... | 129 |
| | III. SOUND SIGNALS TO BE USED BY VESSELS | 129 |
| Annex 7 | WATERWAY SIGNS AND MARKING..... | 135 |
| | I. MAIN SIGNS..... | 135 |
| | A. Prohibitory signs..... | 135 |
| | B. Mandatory signs | 141 |
| | C. Restrictive signs | 145 |
| | D. Recommendatory signs | 147 |
| | E. Informative signs..... | 148 |
| | II. AUXILIARY SIGNS | 160 |
| | A. Panels showing the distance at which the regulation applies or the special feature indicated by the main sign is to be found..... | 160 |
| | B. Additional luminous signal..... | 161 |
| | C. Pointers showing the direction of the section to which the main sign applies..... | 162 |
| | D. Panels giving explanations or additional information..... | 162 |
| Annex 8 | BUOYAGE AND MARKING OF THE WATERWAYS | 163 |
| | I. GENERAL | 163 |
| | A. Marking of waterways..... | 163 |

CONTENTS (continued)

| | | |
|----------|---|-----|
| B. | Definitions | 163 |
| C. | Rhythm of lights | 164 |
| II. | BUOYAGE OF FAIRWAY LIMITS IN THE WATERWAY | 165 |
| A. | Right-hand side of the fairway | 165 |
| B. | Left-hand side of the fairway | 166 |
| C. | Bifurcation of the fairway | 167 |
| III. | MARKS ON LAND INDICATING THE POSITION OF THE FAIRWAY | 168 |
| A. | Marks on land indicating the position of the fairway in relation to the banks | 168 |
| B. | Marking of cross-overs | 172 |
| IV. | BUOYAGE AND MARKING OF DANGER POINTS AND OBSTACLES | 176 |
| A. | Fixed marks | 176 |
| B. | Buoys | 178 |
| IV BIS. | OTHER MARKING OF DANGER POINTS AND OBSTACLES IN THE WATERWAY | 180 |
| A. | Passage permitted on the clear side without reducing speed | 180 |
| B. | Passage permitted on the clear side at reduced speed (avoid creating wash) | 181 |
| V. | ADDITIONAL MARKING FOR NAVIGATION BY RADAR | 182 |
| A. | Marking of bridge piers (where applicable) | 182 |
| B. | Marking of overhead cables (where applicable) | 183 |
| VI. | ADDITIONAL BUOYAGE AND MARKING OF LAKES AND BROAD WATERWAYS | 184 |
| A. | Marking of danger points, obstacles and special features | 184 |
| B. | Marking of the axis of a channel, the middle of a channel or a landfall | 187 |
| C. | Weather signs and signals on lakes | 187 |
| VII. | MARKING OF PROHIBITED OR RESTRICTED AREAS | 188 |
| VIII. | BUOYS FOR MISCELLANEOUS PURPOSES | 189 |
| IX. | ENTRANCES TO HARBOURS | 189 |
| Annex 9 | MODEL USED-OIL LOG | 191 |
| Annex 10 | GENERAL TECHNICAL SPECIFICATIONS APPLICABLE TO RADAR EQUIPMENT | 195 |
| Annex 11 | SAFETY CHECKLIST FOR BUNKERING FUEL | 197 |

Annex to Resolution No. 24 European Code for Inland Waterways CEVNI

Chapter 1 GENERAL PROVISIONS

Article 1.01 – Meaning of certain terms

In these regulations, the following definitions are used:

I. TYPES OF VESSELS

1. The term “vessel” means any inland waterway craft, including small craft and ferry-boats, as well as floating equipment and seagoing vessels;
2. The term “motorized vessel” means any craft using its own mechanical means of propulsion, except craft whose engines are used only to cover short distances (in harbours or at loading and unloading points) or to make them easier to handle while being towed or pushed;
3. The term “floating equipment” means floating structures carrying machinery used for work on waterways or in harbours (dredgers, elevators, derricks, cranes, etc.);
4. The term “ferry-boat” means any vessel providing a transport service across a waterway, that is classed as a ferry-boat by the competent authorities. Vessels providing such a service which do not move independently shall in any case be classified as “ferry-boats”;

5. The term “high-speed vessel” means a motorized vessel, with the exception of small craft, capable of travelling at a speed greater than 40 km/h in relation to water (for example a hydrofoil craft, a hovercraft or a multihull vessel) when this is stated in the ship’s certificate;
6. The term “passenger vessel” means a day-trip or cabin vessel constructed and equipped to carry more than 12 passengers;
7. The term “pushed barge” means any vessel designed or specially equipped to be pushed;
8. The term “shipborne barge” means a pushed barge designed to be carried on board seagoing vessels and to navigate on inland waterways;
9. The term “sailing vessel” means any vessel proceeding under sail only; a vessel proceeding under sail and making use at the same time of its own mechanical means of propulsion shall be considered as a motorized vessel;
10. The term “small craft” means any vessel with a hull less than 20 m long without rudder or bowsprit, except vessels built or equipped to tow, push or propel vessels other than small craft in side-by-side formation and except craft authorized to carry more than 12 passengers, ferry-boats and pushed barges;
11. The term “water bike” means any small craft using its own mechanical means of propulsion, which is able to carry one or more persons and built or designed to be used for skiing over the water or performing figures, for example, waterbobs, waterscooters, jetbikes, jetski and other similar craft;
12. The term “sports or pleasure craft” means any vessel used for purposes of sports and recreation and not financial gain.

II. CONVOYS

1. The term “convoy” means a towed convoy, a pushed convoy or a side-by-side formation;
2. The term “towed convoy” means any group consisting of one or more vessels, floating establishments or assemblies of floating material towed by one or more motorized vessels, the latter forming part of the convoy and being known as tugs;
3. The term “pushed convoy” means a rigid group of vessels, one at least of which is placed in front of the motorized vessel propelling the convoy and is known as a pusher. A convoy composed of a pusher and a pushed craft so as to permit guided articulation is also considered as rigid;
4. The term “side-by-side formation” means a group consisting of vessels coupled side-by-side, none of which is placed in front of the motorized vessel propelling the formation.

III. LIGHT AND SOUND SIGNALS

1. The terms “white light”, “red light”, “green light”, “yellow light” and “blue light” mean lights of colours according to the provisions referred to in Annex 4 to these regulations;
2. The terms “strong light”, “bright light” and “ordinary light” mean lights of intensities according to the provisions referred to in Annex 5 to these regulations;
3. The terms “scintillating light” and “quick scintillating light” mean rhythmic lights flashing 40–60 times per minute and 100–120 times per minute;
4. The term “short blast” means a blast lasting approximately one second, and the term “long blast” means a blast lasting approximately four seconds, the interval between two consecutive blasts being about one second;
5. The term “series of very short blasts” means a series of at least six blasts lasting approximately $\frac{1}{4}$ second each, separated by intervals of approximately $\frac{1}{4}$ second;
6. The term “three-tone signal” means a signal repeated three times, of three blasts of different pitch with no interval between them lasting about two seconds in all. The frequency of the blasts shall be within the range 165 to 297 Hertz and the difference between the highest and the lowest blasts shall be at least two full notes. Each series of three blasts shall begin with the lowest and end with the highest note;
7. The term “peal of a bell” means two strokes of a bell.

IV. OTHER TERMS

1. The term “floating establishment” means any floating installation that is normally stationary, e.g. swimming baths, docks, wharves or boat-sheds;
2. The term “assembly of floating material” means a raft or any construction, assembly or object capable of navigation, other than a vessel or floating establishment;
3. A vessel, an assembly of floating material or a floating establishment is “stationary” when it is, directly or indirectly, anchored or made fast to the shore;
4. A vessel, an assembly of floating material or a floating establishment is “under way” or “proceeding” when it is neither directly nor indirectly at anchor, made fast to the shore or grounded. For such vessels, floating equipment or floating establishments under way, the term “stop” applies with respect to the land;
5. The term “vessel engaged in fishing” means any vessel fishing with nets, lines, trawls or other fishing apparatus that restrict manoeuvrability, but does not apply to a vessel fishing with trolling lines or other fishing apparatus that does not restrict manoeuvrability;
6. The term “night” means the period between sunset and sunrise;

7. The term “day” means the period between sunrise and sunset;
8. The term “state of fatigue” means a state occurring as the result of insufficient rest or of sickness, and expressed in deviations from the norm in behaviour and reaction speed;
9. The term “state of intoxication” means a state occurring as a result of the use of alcohol, narcotics, medicines or other substances and determined in accordance with national legislation and practice;
10. The term “reduced visibility” means conditions in which visibility is reduced owing to e.g fog, haze, snow or rain;
11. The term “safe speed” means a speed at which a vessel or a convoy can navigate safely, undertake manoeuvres and stop within the distance required by the prevailing circumstances and conditions;
12. The term “waterway” means any inland water open to navigation;
13. The term “fairway” means that part of the waterway that can actually be used for navigation;
14. The term “left and right banks” means the sides of the waterway when moving from the source to the mouth;

On canals, lakes and broad waterways the term “left and right banks” is assigned by the competent authorities in light of local conditions. However, it is recommended that for canals, the terms “right” and “left” should be defined as meaning to the right and to the left respectively of an observer facing the direction in which the numbers indicated on successive kilometer markings increase;
- 14 bis. The designations “right-hand side” and “left-hand side” of the waterway or fairway are understood to be for an observer facing downstream. On canals, lakes and broad waterways, the terms “right-hand side” and “left-hand side” are defined by the competent authorities;
15. The term “upstream” means the direction towards the source of the river, including sections where the current changes with the tide. On canals, the direction shall be determined by the competent authorities and the term “in the direction from point A to point B” shall be used. “Downstream” means the other way around;
16. The term “ADN” means the Regulations annexed to the European Agreement Concerning the International Carriage of Dangerous Goods by Inland Waterways;
17. The term “navigation by radar” means navigation, in conditions of reduced visibility, using the radar;
18. The term ‘inland AIS device’ means a device that is installed on board of a vessel and is used within the meaning of the ‘tracking and tracing in inland navigation’ standard.

Article 1.02 – Boatmaster

1. Every vessel or assembly of floating material, except vessels in a pushed convoy other than the pusher, shall be placed under the authority of a person having the necessary qualifications. This person is hereinafter referred to as the boatmaster. Boatmasters are considered to possess the necessary qualifications if they hold a valid boatmaster's certificate.
2. Every convoy shall likewise be placed under the authority of a person having the necessary qualifications. This boatmaster shall be appointed as follows:
 - (a) In the case of a convoy with only one motorized vessel, the boatmaster of the convoy shall be the boatmaster of the motorized vessel;
 - (b) In the case of a towed convoy led by two or more motorized vessels in line, the boatmaster of the convoy shall be the boatmaster of the leading vessel, unless that vessel is a temporary auxiliary tug, in which case the boatmaster of the convoy shall be the boatmaster of the second vessel;
 - (c) In the case of a towed convoy led by two or more motorized vessels not in line, one of which provides the main traction, the boatmaster of the convoy shall be the boatmaster of the vessel providing the main traction;
 - (d) In a pushed convoy propelled by two pushers side-by-side, the boatmaster of the pusher providing the main propulsion shall be the boatmaster of the convoy;
 - (e) In all other cases, the boatmaster of the convoy shall be designated.
3. When a vessel is under way the boatmaster shall be on board; in addition, the boatmaster of floating equipment shall always be on board when the equipment is in operation.
4. The boatmaster is responsible for compliance with these regulations on his vessel, convoy or assembly of floating material. In a towed convoy, the boatmasters of the towed vessels shall obey the orders of the boatmaster of the convoy; however, even without such orders, they shall take all steps required by the circumstances for the proper handling of their vessels. The same provisions apply to boatmasters of vessels in a side-by-side formation who are not the boatmaster of the formation.
5. Every floating establishment shall be placed under the authority of a person. This person shall be responsible for the observance of the provisions of these regulations on the floating establishment.
6. The faculties of the boatmaster shall not be impaired as a result of a state of fatigue or intoxication.

7. In the case of a moored vessel or assembly of floating material having no boatmaster, the person responsible for ensuring compliance with the provisions of these regulations shall be:

- (a) The person responsible for keeping watch and surveillance under article 7.08;
- (b) The operator and owner of such vessel or assembly if the person referred to in letter (a) is absent.

Article 1.03 – Duties of crew and other persons on board

1. Crew members shall carry out the orders given to them by the boatmaster in the performance of his duties. They shall assist in complying with the requirements of these regulations and of any other provisions applicable.
2. All other persons on board are required to comply with the orders given to them by the boatmaster in the interest of safe navigation or of good order on board.
3. Members of the crew and other persons on board who temporarily determine the vessel's course and speed themselves shall also be responsible in that respect for ensuring compliance with the requirements of these regulations.
4. The faculties of crew members on duty and other persons on board who participate temporarily in the navigation of the vessel shall not be impaired as a result of a state of fatigue or intoxication.

Article 1.04 – General obligation to exercise vigilance

1. When under way every vessel shall at all times proceed at a safe speed.
2. Even where no special rules are laid down in these regulations, boatmasters shall take all the precautions required by the general obligation to exercise vigilance and good navigational practice in order to avoid, in particular:
 - (a) Danger to human life;
 - (b) Damage to vessels or assemblies of floating material, banks, works or installations of any kind on or adjacent to the waterway;
 - (c) Causing obstructions to navigation; and
 - (d) Causing inordinate harm to the environment.
3. Paragraph 2 shall also apply to persons in charge of floating establishments.

Article 1.05 – Conduct in special circumstances

To avoid imminent danger, boatmasters shall take all the steps required by the situation, even if this entails departing from these regulations.

Article 1.06 – Use of the waterway

The length, width, height, draught and speed of vessels, convoys and assemblies of floating material shall be suited to the characteristics of the waterway and its installations.

Article 1.07 – Maximum load, maximum number of passengers and view

1. Vessels shall not be loaded beyond their maximum draught markings.
2. The load or the list of the vessel shall not restrict the direct view at a distance of more than 350 m in front of the vessel. If direct visibility astern and aside is restricted during the voyage, this lack of visibility may be compensated for by the use of radar apparatus.
3. The load shall not endanger the vessel's stability or strength of the hull.
4. In addition, the stability of vessels carrying containers shall be checked before departure for the following cases:
 - (a) for vessels with a beam of less than 9.5 m, loaded with more than one tier of containers;
 - (b) for vessels with a beam of 9.5 m or more but less than 11 m, loaded with more than two tiers of containers;
 - (c) for vessels with a beam of 11 m or more but less than 15 m, loaded with more than three tiers of containers or more than three widths;
 - (d) for vessels with a beam of 15 m or more, loaded with more than three tiers of containers.
5. Passenger vessels shall not have on board more passengers than the number authorized by the competent authorities. High-speed passenger vessels shall not have on board more persons than the number of available seats.

Article 1.08 – Construction, rigging and crews of vessels

1. Vessels and assemblies of floating material shall be so constructed and rigged as to ensure the safety of those on board and safe navigation and to be able to satisfy the requirements of these regulations.
2. All vessels, except vessels in a pushed convoy other than the pusher, shall have a crew sufficient in number and sufficiently skilled to ensure the safety of those on board and safe navigation. However, non-motorized vessels in a side-by-side formation and some of the towed vessels in a rigid group are not required to have a crew if the vessel propelling the side-by-side formation or rigid group, or keeping it safely stopped, has a crew sufficiently large and skilled to ensure the safety of those on board and safe navigation.
3. The requirements set out in paragraphs 1 and 2 above are considered to be complied with when the ship has a ship's certificate, issued in accordance with the Recommendations on Harmonized Europe-Wide Technical Requirements for Inland Navigation Vessels (Resolution No. 61), or other recognized ship's certificate, and when the construction and the equipment of the vessel correspond to the content of the ship's certificate.
4. Without prejudice to paragraph 3, the individual life-saving equipment listed in No. 44 of the ship's certificate shall be available for distribution and shall correspond to the number of adult and child passengers.

Article 1.09 – Steering

1. When under way, a vessel shall be steered by at least one qualified person of not less than 16 years of age.
2. The age requirement shall not apply in the case of small craft having no motive power of its own.
3. In order to ensure proper control of the vessel, the helmsman shall be able to receive and give all information and all orders reaching or proceeding from the wheelhouse. In particular, he shall be able to hear sound signals and have a sufficiently clear view in all directions.
4. When particular circumstances so require, a look-out or listening-post shall be set up to keep the helmsman informed.
5. When under way, all high-speed vessels shall be steered by a person not younger than 21 years of age who has the necessary qualifications referred to in article 1.02, paragraph 1 and the certificate referred to in article 4.06, paragraph 1 (b). A second

person who also holds these documents shall be in the wheelhouse except during berthing and casting off and in locks and their forebays.

Article 1.10 – Vessel’s papers and other documents

1. The following documents shall be available on board:
 - (a) Ship’s certificate;
 - (b) A measurement certificate if applicable;
 - (c) Crew list;
 - (d) A ship’s log;
 - (e) Boatmaster’s certificate or certificates belonging to boatmasters of the vessel and for other crew members a service record duly completed,
 and any other documents relating to navigation required under international conventions or agreements.
2. By derogation from paragraph 1 above, small craft are not required to carry the documents referred to in subparagraphs (b) and (d); moreover, in the case of small pleasure craft, the document referred to in subparagraph (c) is not required, and that referred to in subparagraph (a) may be replaced by a national navigation permit.
3. If applicable, assemblies of floating material shall carry a national navigation permit.
4. The documents required to be carried on board under these regulations or any other provisions applicable shall be produced whenever requested by officials of the competent authorities.
5. However, the ship’s certificate and the measurement certificate need not be carried on board a pushed barge to which is affixed a metal or plastic plate conforming to the following model:

| |
|---|
| Unique European vessel identification number: |
| Ship’s certificate No.: |
| Competent authority: |
| Expiry date: |

These particulars shall be engraved or stamped or permanently printed in easily legible characters not less than 6 mm high. The plate shall be not less than 60 mm high

and 120 mm long; it shall be permanently affixed in a prominent place towards the stern of the barge on the starboard side.

The conformity of the particulars given on the plate to those in the barge's ship's certificate shall be certified by the competent authority, whose stamp shall be applied to the plate. The ship's certificate and measurement certificate shall be kept by the operator of the barge.

Article 1.11 – Navigation regulations

1. An updated copy of the navigation regulations applicable to the waterway shall be carried on board of every vessel, except unmanned vessels, open small crafts and assemblies of floating material.
2. An electronic version is acceptable when readable at short notice.

Article 1.12 – Dangerous objects on board; loss of objects; obstacles

1. It is prohibited to allow objects that would constitute a danger to vessels, assemblies of floating material or floating establishments on or adjacent to the waterway to project beyond the sides of vessels or of assemblies of floating material.
2. Anchors shall be in the fully raised position unless they are used.
3. When a vessel, an assembly of floating material or a floating establishment loses an object and this may cause an obstruction or danger to navigation, the boatmaster or the person responsible for the floating establishment shall at once inform the nearest competent authorities, specifying as accurately as possible the place where the object was lost. If possible, he shall also place a marker at the spot.
4. When a vessel encounters an unknown obstacle on a waterway, the boatmaster shall at once inform the nearest competent authority, specifying as accurately as possible the place where the obstacle was encountered.

Article 1.13 – Protection of waterway signs and marking

1. It is prohibited to use waterway signs or marking (such as boards, buoys, floats, beacons, warning rafts with waterway signs) for mooring or warping vessels or assemblies of floating material, to damage them or to render them unfit for use.
2. When a vessel or an assembly of floating material has displaced or damaged any device or installation which is part of the system of waterway signs and marking, the boatmaster shall at once inform the nearest competent authority.

3. Every boatmaster has a general duty immediately to inform the nearest competent authority of any incident or accident affecting waterway signs or marking (such as failure of a light, displacement of a buoy, destruction of a sign).

Article 1.14 – Damage to permanent structures

When a vessel or assembly of floating material has damaged a permanent structure (lock, bridge, groyne, etc.), the boatmaster shall at once inform the nearest competent authority.

Article 1.15 – Prohibition of discharge into the waterways

1. It is forbidden to throw, pour or allow to fall or flow into a waterway any objects or substances likely to cause an obstruction or danger to navigation or to other users of the waterway.

2. In the event of such accidental spillage or any risk of such spillage, the boatmaster shall immediately inform the nearest competent authority, specifying as accurately as possible the nature and site of the spillage.

Article 1.16 – Salvage and assistance

1. In the event of an accident endangering persons on board, the boatmaster shall use every means at his disposal to save them.

2. Every boatmaster who is close to a vessel or assembly of floating material which has suffered an accident endangering persons or threatening to obstruct the fairway is required to give immediate assistance insofar as is consistent with the safety of his own vessel.

Article 1.17 – Grounded or sunken vessels

1. The boatmaster of a grounded or sunken vessel or of a grounded or broken assembly of floating material shall arrange for the nearest competent authority to be informed as soon as possible. In the case of a grounded or sunken vessel, the boatmaster or a member of the crew shall remain on board or near the site of the accident until the competent authority has authorized him to leave.

2. When a vessel is grounded or sunk, or an assembly of floating material is grounded, in or near the fairway, its boatmaster shall, unless it is obviously unnecessary, as soon as possible and without prejudice to the obligation to display the marking referred to in article 3.25, give warning to approaching vessels and assemblies of floating material at suitable points far enough from the site of the accident to enable them to take the necessary action in good time.

3. Should an accident occur while a vessel is passing through a lock, the boatmaster shall immediately inform the service in charge of the lock in question.

Article 1.18 – Obligation to clear the fairway

1. When a grounded or sunken vessel, a grounded assembly of floating material or an object lost by a vessel or assembly of floating material causes or threatens to cause total or partial obstruction of the fairway, the boatmaster of the vessel or assembly of floating material shall endeavour to get the fairway cleared as soon as possible.

2. A boatmaster whose vessel or assembly of floating material is in danger of sinking or becomes impossible to control is under the same obligation.

Article 1.19 – Special instructions

Boatmasters and persons in charge of floating establishments shall comply with any special instructions given to them by officials of the competent authorities in order to ensure safe and orderly navigation. Subject to compliance with the provisions of relevant international agreements, this shall also apply in the event of a cross-border hot pursuit.

Article 1.20 – Inspection

1. Boatmasters and persons in charge of floating establishments shall give officials of the competent authorities the necessary facilities for verifying compliance with these regulations and any other provisions applicable, and in particular facilitate immediate boarding by them.

2. Authorized officials of the competent authorities may, except in special cases when the provisions of other legislation are applied, by means of a special decision prohibit the navigation of a vessel and, in particular, in the following cases:

- (a) When the vessel does not have a ship's certificate or national navigation permit or these documents have expired;
- (b) When the vessel does not comply with the conditions referred to in article 1.07;
- (c) When the crew or the vessel does not comply with the conditions referred to in article 1.08;
- (d) When the capabilities of the boatmaster or on-duty crew members have been diminished due to a state of fatigue or intoxication.

Article 1.21 – Special transport operations

1. Movements on inland waterways are deemed to be special transport operations if they are movements of:
 - (a) Vessels or convoys which do not comply with the requirements of articles 1.06 and 1.08;
 - (b) Floating establishments or assemblies of floating material, unless it is evident that their movement cannot cause any hindrance or danger to navigation or any damage to permanent structures.
2. Such a transport operation shall be allowed only under a special authorization issued by the competent authorities of the sector or sectors over which it is to take place.
3. It shall be subject to such conditions as those authorities may determine in each case.
4. A boatmaster shall be appointed for each transport operation, account being taken of the provisions of article 1.02.

Article 1.22 – Special temporary requirements

1. Boatmasters shall comply with any temporary requirements issued by a competent authority in special circumstances to ensure safe and orderly navigation.
2. These requirements may be justified by work carried out on the inland waterway, military exercises, public events within the meaning of article 1.23 or conditions of the waterway; they may, in specific sections where particular precautions are necessary and are indicated by buoys, beacons or other signs or by alarms, restrict or prohibit navigation or the passage of vessels with too large a draught.

Article 1.23 – Authorization of public events

Sporting events, regattas or other public events which may endanger safe and orderly navigation shall be subject to authorization by the competent authorities.

Article 1.24 – Applicability in ports, loading and unloading zones

These regulations shall also apply to water surfaces that are a part of ports and loading and unloading zones, without prejudice to the specific requirements of the waterway police enacted for these ports and loading and unloading zones and called for by local conditions and loading and unloading operations.

Chapter 2

MARKS AND DRAUGHT SCALES ON VESSELS; TONNAGE MEASUREMENT

Article 2.01 – Identification marks on vessels other than small craft and seagoing vessels

1. Every vessel, except small craft and seagoing vessels, shall bear the following identification marks on its hull or on fixed boards or plates:

- (a) Its name, which can also be an abbreviation or a number

The name shall be inscribed on both sides of the vessel, except for the pushed barges, it shall also be inscribed in a position visible from astern. If, in a side-by-side formation or pushed convoy, one or more of the inscriptions of the propelling vessel's name are hidden, the name shall be reproduced on boards so placed as to be clearly visible from the directions from which those inscriptions are hidden. If the vessel has no name, it shall bear either the name (or its usual abbreviation) of the organization to which it belongs followed, where applicable, by a number, or the registration number followed, in order to show the country of the vessel's home port or place of registry, by the letter or letters assigned to that country in annex 1 to these regulations.

- (b) Its home port or place of registry

The name of the home port or place of registry shall be inscribed either on both sides of the vessel or on its stern and shall be followed by the letter or letters indicating the country of that home port or place of registry.

- (c) One of the following

(i) Its unique European vessel identification number, which is made up of eight Arabic numerals. The first three digits are used to identify the country and the office where this unique European vessel identification number was

assigned. This identification mark is mandatory only for vessels that have been assigned a unique European vessel identification number;

or

(ii) Its official number, which is made up of seven Arabic numerals, possibly followed by a letter in lower-case type. The first two digits are used to identify the country and the office where this official number was assigned. This identification mark is mandatory only for vessels which were assigned an official number that has not yet been converted into a unique European vessel identification number.

The unique European vessel identification number or the official number shall be displayed under the conditions laid down in subparagraph (a) above.

2. In addition, except for small craft and seagoing vessels:
 - (a) Every cargo vessel shall have its dead-weight tonnage inscribed on both sides, on the hull or on fixed boards or plates;
 - (b) Every passenger vessel shall display the maximum permissible number of passengers in a conspicuous position on board.
3. The above-mentioned identification marks shall be inscribed in easily legible and indelible Latin characters, their inscription in oil paint being considered indelible. The height of the characters shall be not less than 20 cm for the name and not less than 15 cm for other marks. The width of the characters and the thickness of strokes shall be in proportion to the height. The characters shall be of a light colour against a dark background or vice versa.
4. As an exception to the preceding paragraphs, seagoing vessels may maintain their identification marks.
5. Crewed vessels under way by day shall fly their national flag at the stern. High-speed vessels may instead of the national flag display a board which matches the national flag in shape and colour.

Article 2.02 – Identification marks on small craft

1. Small craft shall bear the official registration marks; if those marks are not prescribed, they shall bear:
 - (a) Their name, which can also be an abbreviation or a number;
 - (b) The name and domicile of the owner.

2. The registration or identification marks mentioned under paragraph 1 (a) shall be inscribed on the outside of the small craft in Latin characters not less than 10 cm high, easily legible and indelible, their inscription in oil paint being considered indelible. If the small craft has no name, it shall bear the name (or its usual abbreviation) of the organization to which it belongs, followed, where applicable, by a number.

3. The name and domicile of the owner shall be displayed in a conspicuous position inside or outside the craft.

4. However, ship's boats need only bear, inside or outside, the name of the vessel to which they belong and any other particulars needed to identify the owner.

Article 2.03 – Tonnage measurement

Every inland waterway cargo vessel, except small craft, shall have its tonnage capacity measured.

Article 2.04 – Draught marks and draught scales

1. All vessels, except small craft, shall bear marks showing the maximum draught level. In the case of inland waterway vessels, the methods by which the maximum draught is determined and the conditions to be observed in affixing the draught marks shall be laid down in the rules concerning technical requirements which correspond to the Recommendations on Harmonized Europe-Wide Technical Requirements for Inland Navigation Vessels (Resolution No. 61). In the case of seagoing vessels, the summer fresh-water line shall serve in place of draught marks.

2. Every vessel which may draw as much as 1 m of water except for small craft shall be provided with draught scales. In the case of inland waterway vessels, annex 2 to these regulations lays down the conditions to be observed in affixing the draught scales.

Article 2.05 – Identification marks on anchors

1. The anchors of vessels shall bear identification marks in indelible characters. These shall include at least the European Identification Number (ENI), if applicable.

If an anchor is used on another vessel belonging to the same owner, the original marking may be kept.

2. The obligation contained in paragraph 1 shall not apply to the anchors of seagoing vessels or of small craft.

Chapter 3

VISUAL SIGNALS (MARKING) ON VESSELS

I. GENERAL

Article 3.01 – Application and definitions

1. When visibility conditions so require, the visual signals prescribed for use at night shall also be displayed by day.
2. Sketches of the signals prescribed in this chapter are contained in annex 3 to these regulations.
3. In this chapter:
 - (a) The term “masthead light” means a strong white light projecting an uninterrupted beam throughout a horizontal arc of 225° and placed so as to project that beam from the bow to $22^{\circ}30'$ abaft the beam on each side;
 - (b) The term “side lights” means a bright green light to starboard and a bright red light to port, each of these lights projecting an uninterrupted beam throughout a horizontal arc of $112^{\circ}30'$ and placed so as to project that beam from the bow to $22^{\circ}30'$ abaft the beam on its side;
 - (c) If not prescribed otherwise, the term “stern light” means an ordinary or bright white light projecting an uninterrupted beam throughout a horizontal arc of 135° and placed so as to project this beam throughout an arc of $67^{\circ}30'$ along each side from the stern;
 - (d) The term “light visible from all directions” means a light projecting an uninterrupted beam throughout a horizontal arc of 360° ;
 - (e) The term “height” means the height above the level of the maximum draught marks or, for vessels without draught marks, above the waterline.

4. When passing through the opening of a fixed or closed bridge or weir, or when passing through locks, vessels may carry the lights, boards, balls, etc. provided for in this chapter at a reduced height so that passage may be effected without difficulty.

Article 3.02 – Lights

Unless otherwise provided, the lights prescribed in these regulations shall show a continuous and uniform beam.

Article 3.03 – Boards, flags and pennants

1. Unless otherwise provided, the boards and flags prescribed in these regulations shall be rectangular.
2. The colours of the boards, flags and pennants shall not be faded or dirty.
3. They shall be large enough to be easily visible; this condition shall be considered to be satisfied in all cases:
 - (a) For the boards and flags if neither the length nor the width is less than 1 m or, in the case of small craft, less than 0.60 m;
 - (b) For the pennants if the length is not less than 1 m and the breadth at the staff not less than 0.50 m.

Article 3.04 – Cylinders, balls, cones and bicones

1. The cylinders, balls, cones and bicones prescribed in these regulations may be replaced by devices having the same appearance when seen from a distance.
2. Their colours shall not be faded or dirty.
3. The following minimal dimensions shall be met:
 - (a) For cylinders, a height of 0.80 m and a diameter of 0.50 m;
 - (b) For balls, a diameter of 0.60 m;
 - (c) For cones, a height of 0.60 m and a diameter at the base of 0.60 m;
 - (d) For bicones, a height of 0.80 m and a diameter at the base of 0.50 m.
4. Notwithstanding paragraph 3, for small craft the use of signal body with smaller dimension is permitted, as long as these bodies are large enough to be easily visible.

Article 3.05 – Prohibited lights and signals

1. The use of any lights or signals other than those mentioned in these regulations or the use of those mentioned otherwise than as prescribed or permitted by these regulations is prohibited.
2. However, for communication between vessels or between a vessel and the shore, the use of other lights or signals is permitted provided they are not liable to be confused with those mentioned in these regulations.

Article 3.06 – Emergency lights

When signal lights prescribed by these regulations cease to function, they shall be replaced by emergency lights without delay. However, where the prescribed light is strong, the emergency light may be bright and, where the prescribed light is bright, the emergency light may be ordinary. Lights of the prescribed power shall be brought into operation again as soon as possible.

Article 3.07 – Prohibited use of lamps, searchlights, boards, flags, etc.

1. The use of lamps or searchlights or of boards, flags or other objects in such a way that they may be confused with the lights or signals mentioned in these regulations or impair their visibility or complicate their identification is prohibited.
2. The use of lamps or searchlights in such a way that they cause dazzle constituting a danger or disturbance to navigation or to traffic on the banks of the waterway is prohibited.

II. NIGHT AND DAY MARKING

A. MARKING WHEN UNDER WAY

Article 3.08 – Marking for motorized vessels proceeding alone

1. Single motorized vessels shall carry:
By night:
 - (a) A masthead light forward and in the axis of the vessel, at a height of not less than 5 m. The height may be reduced to 4 m, when the vessel does not exceed a length of 40 m;
 - (b) Side lights, each placed at the same height and on the same perpendicular to the axis of the vessel, 1 m lower than the masthead light, at least 1 m abaft of

it on the widest part of the vessel; they shall be screened inboard so that the green light cannot be seen from the port side and the red light cannot be seen from the starboard side;

(c) A stern light, placed aft and in the axis of the vessel.

2. A single motorized vessel more than 110 m long shall be required to carry by night at the stern a second masthead light placed in the axis of the vessel and at least 3 m higher than the forward light.

3. A single motorized vessel temporarily preceded by night by an auxiliary motorized vessel shall continue to show the lights referred to in paragraphs 1 and 2 above.

4. In addition to the marking prescribed by other provisions of these regulations, high-speed vessels under way shall carry by day and by night:

two strong yellow quick scintillating lights.

These scintillating lights shall be placed one above the other about 1 m apart, in a suitable position and high enough to be visible from all directions.

5. The provisions of this article shall not apply to small craft or ferry-boats.

Article 3.09 – Marking for towed convoys under way

1. A motorized vessel leading a towed convoy, and a motorized vessel used as an auxiliary in front of another motorized vessel, a pushed convoy or a side-by-side formation shall carry:

By night:

- (a) Two masthead lights one above the other about 1 m apart, placed forward and in the axis of the vessel, the upper light being at a height of, at least, 5 meters and the lower light, so far as possible, at least 1 m higher than the side lights;
- (b) The side lights prescribed in article 3.08, paragraph 1 (b);
- (c) A yellow instead of a white stern light, placed in the axis of the vessel and high enough to be clearly visible from the towed unit following the vessel or the motorized vessel, pushed convoy or side-by-side formation in front of which the vessel is used as an auxiliary;

By day:

A yellow cylinder, with two black and white stripes at top and bottom, the white stripes being at the ends of the cylinders. The cylinder shall be placed vertically forward, and high enough to be visible from all directions.

2. Where a towed convoy is led by several motorized vessels, or where a motorized vessel, pushed convoy or side-by-side formation is preceded by several auxiliary

motorized vessels proceeding side-by-side, whether coupled or not, each of those vessels shall carry:

By night:

Instead of the masthead lights prescribed in 1 (a) above, three masthead lights one above the other about 1 m apart, placed forward in the axis of the vessel, the top and bottom lights being at the same height as those prescribed in paragraph 1 (a);

By day:

The cylinder prescribed in paragraph 1 above.

Where a vessel, an assembly of floating material or a floating establishment is being manoeuvred by more than one motorized vessel, this requirement shall apply to each of them.

3. Vessels in a towed convoy following the motorized vessel or vessels referred to in paragraphs 1 and 2 above shall carry:

By night:

A bright white light visible from all directions, placed at a height of at least 5 m. This height may be reduced to 4 m for vessels whose length does not exceed 40 m;

By day:

A yellow ball in a suitable position and high enough to be visible from all directions.

However,

- (a) If a section of the convoy is more than 110 m long, that section shall carry two such lights, one forward and one aft;
- (b) If a section of the convoy comprises a row of more than two vessels coupled side-by-side, only the two outside vessels of the row shall carry such lights or such a ball.

The marking of all towed vessels in a convoy shall so far as possible be carried at the same height above the water level.

4. The vessel or vessels forming the last section of a towed convoy shall carry, in addition to the marking prescribed in paragraph 3 above:

By night:

The stern light prescribed in article 3.08, paragraph 1 (c).

However, if the convoy ends with a row of more than two vessels coupled side-by-side, only the two outside vessels of the row shall carry such lights. If the rear of the

convoy is made up of small craft, those craft shall not be taken into account for the provisions of this paragraph.

5. Where the vessels referred to in paragraph 3 above are seagoing vessels coming directly from or leaving for the sea, they may carry:

By night:

Instead of the white light, the side lights prescribed in article 3.08, paragraph 1 (b);

By day:

The yellow ball.

6. The provisions of this article shall not apply to small craft towing only other small craft or to the towing of small craft.

Article 3.10 – Marking for pushed convoys under way

1. Pushed convoys shall carry:

By night:

- (a) (i) Three masthead lights at the bow of the leading vessel or the vessel on the port side at the head of the convoy. These lights shall be arranged in an equilateral triangle with a horizontal base, in a plane perpendicular to the longitudinal axis of the convoy. The top light shall be at a height of not less than 5 m. The two lower lights shall be about 1.25 m apart and about 1.10 m below the top light;
- (ii) A masthead light at the bow of any other vessel whose full width is visible from ahead. This light shall so far as possible be 3 m below the top light referred to under (i).

The masts carrying these lights shall be in the longitudinal axis of the vessel in which they are carried;

- (b) The side lights prescribed in article 3.08, paragraph 1 (b); these lights shall be placed on the widest part of the convoy, as near the pusher as possible, not more than 1 m from the sides of the convoy and at a height of not less than 2 m;
- (c) (i) Three stern lights as prescribed in article 3.08, paragraph 1 (c) on the pusher, placed in a line perpendicular to its longitudinal axis, about 1.25 m apart and high enough not to be hidden by another vessel in the convoy;

- (ii) A stern light on every vessel whose full width is visible from astern; however, when more than two vessels other than the pusher are visible from astern, this light shall be carried only by the two vessels on the outside of the convoy.

2. The provisions of paragraph 1 above shall also apply to pushed convoys preceded by night by one or more auxiliary motorized vessels; however, the stern lights referred to in paragraph 1 (c) (i) above shall be yellow instead of white.

When a pushed convoy is preceded by day by one or more auxiliary motorized vessels, the pusher shall carry the yellow ball referred to in article 3.09, paragraph 3.

3. Pushed convoys with two pushers in side-by-side formation shall carry by night the stern lights prescribed in paragraph 1 (c) (i) on the pusher providing the main propulsion, the other pusher shall carry the stern light prescribed in paragraph 1 (c) (ii) above.

4. For the application of this chapter, pushed convoys whose maximum dimensions do not exceed 110 m by 12 m are regarded as single motorized vessels.

5. The provisions of this article shall not apply to small craft pushing only other small craft or to the pushing of small craft.

Article 3.11 – Marking for side-by-side formations under way

1. Side-by-side formations shall carry:

By night:

- (a) The masthead light prescribed in article 3.08, paragraph 1 (a), on each vessel; however, each non-motorized vessel may, instead of the masthead light, carry the white light prescribed in article 3.09, paragraph 3, visible from all directions, in a suitable position but not higher than the masthead light of the motorized vessel or vessels;
- (b) The side lights prescribed in article 3.08, paragraph 1 (b); these lights shall be placed on the outside of the formation, so far as possible at the same height and at least 1 m below the lowest masthead light;
- (c) The stern light prescribed in article 3.08, paragraph 1 (c), on each vessel.

2. The provisions of paragraph 1 above shall also apply to side-by-side formations preceded by night by one or more auxiliary motorized vessels.

When a side-by-side formation is preceded by day by one or more auxiliary motorized vessels, each vessel in the formation shall carry the yellow ball referred to in article 3.09, paragraph 3.

3. The provisions of this article shall not apply to small craft propelling only small craft in a side-by-side formation, or to small craft so propelled.

Article 3.12 – Marking for sailing vessels under way

1. Sailing vessels shall carry:

By night:

- (a) The side lights prescribed in article 3.08, paragraph 1 (b); however these lights may be ordinary, instead of bright;
- (b) The stern light prescribed in article 3.08, paragraph 1 (c).

2. In addition to the lights prescribed in paragraph 1 of this article, a sailing vessel may carry:

By night:

Two ordinary or bright lights one above the other, visible from all directions, the upper light being red and the lower green; these lights shall be in a suitable position at the top or on the upper part of the mast and not less than 1 m apart.

3. All vessels under sail and simultaneously using their own mechanical means of propulsion shall carry:

By night:

The lights according to paragraph 1 and one masthead light instead of the lights according to paragraph 2.

By day:

A black cone, point downwards.

This cone shall be positioned as high as possible and where it will be most obvious.

4. The provisions of paragraphs 1 and 2 of this article shall not apply to small craft. The provisions of paragraph 2 shall not apply to the vessels referred to in article 3.35.

Article 3.13 – Marking for small craft under way

1. Motorized small craft proceeding alone shall carry by night either:

- (a) A masthead light, bright instead of strong, at the same height as the side lights and not less than 1 m forward of them;
- (b) Side lights, which may be ordinary lights; they shall be at the same height and on the same perpendicular to the axis of the craft and be screened inboard so

that the green light cannot be seen from the port side and the red light cannot be seen from the starboard side;

(c) A stern light;

or

(d) The masthead light prescribed in subparagraph (a) above; however, this light is to be placed at least 1 m higher than the side lights;

(e) The side lights prescribed in subparagraph (b) above; however, these lights may be placed side by side or in the same lamp in the axis of the craft, at or near the bow;

(f) A stern light; however, this light may be waived provided that the masthead light referred to in subparagraph (d) above is a bright white light visible from all directions.

2. Motorized small craft less than 7 m long proceeding alone may carry, instead of the lights prescribed in paragraph 1 above, an ordinary white light in a suitable position and high enough to be visible from all directions.

3. When a small craft is towing or propelling in side-by-side formation only other small craft, it shall carry by night the lights prescribed in paragraph 1 above.

4. Small craft in tow or propelled in side-by-side formation shall carry by night an ordinary white light visible from all directions. This provision shall not apply to ships' boats.

5. Small sailing craft under way shall carry:

By night:

Side lights and stern light, the side lights being placed side-by-side or in the same lamp in the axis of the craft, at or near the bow, and the stern light being placed in the after part of the craft; however, these lights may be ordinary lights; or

Side lights and a stern light in the same lamp placed in a suitable position at the top or on the upper part of the mast; this light may be an ordinary light; or

In the case of craft less than 7 m long, an ordinary white light visible from all directions. On the approach of other vessels, such craft shall in addition display a second ordinary white light.

6. Small craft proceeding alone which are neither motorized nor under sail shall carry:

By night:

An ordinary white light visible from all directions.

However, ships' boats under these conditions need not display this light except on the approach of other vessels.

7. A small craft under sail and at the same time employing a motor shall carry:

By day:

A black cone with the vertex pointing downwards. This cone shall be positioned as high as possible and where it will be most obvious.

Article 3.14 – Additional marking for vessels carrying out certain transport operations involving dangerous substances

1. Vessels carrying out transport operations involving certain flammable substances that are referred to in ADN shall carry, in addition to the marking prescribed elsewhere in these regulations, the following marking in accordance with the requirements of sub-section 7.1.5.0 or sub-section 7.2.5.0 of ADN:

By night:

A blue light;

By day:

A blue cone, point downwards,

as indicated in ADN, Chapter 3.2, Table A, column (12) or Table C, column (19).

These markings shall be in a suitable position and high enough to be visible from all directions. The blue cone may be replaced by one blue cone at the bow and one blue cone at the stern of the vessel, at a height of not less than 3 m.

2. Vessels carrying out transport operations involving substances constituting health hazards that are referred to in ADN shall carry, in addition to the marking prescribed elsewhere in these regulations, the following marking, in accordance with the requirements of sub-section 7.1.5.0 or sub-section 7.2.5.0 of ADN:

By night:

Two blue lights;

By day:

Two blue cones, point downwards,

as indicated in ADN, Chapter 3.2, Table A, column (12) or Table C, column (19).

These markings shall be placed about 1 m one above the other, in a suitable position and high enough to be visible from all directions. The two blue cones may be replaced by two blue cones at the bow and two blue cones at the stern of the vessel at a height not less than 3 m.

3. Vessels carrying out transport operations involving explosives that are referred to in ADN shall carry, in addition to the marking prescribed elsewhere in these regulations, the following marking, in accordance with the requirements of sub-section 7.1.5.0 or sub-section 7.2.5.0 of ADN:

By night:

Three blue lights;

By day:

Three blue cones, point downwards,

as indicated in ADN, Chapter 3.2, Table A, column (12).

These markings shall be about 1 m one above the other, in a suitable position and high enough to be visible from all directions. The three blue cones may be replaced by three blue cones at the bow and three blue cones at the stern of the vessel at a height of not less than 3 m.

4. When a pushed convoy or side-by-side formation includes one or more of the vessels referred to in paragraphs 1, 2 or 3 above, the marking prescribed in paragraphs 1, 2 or 3 above shall be carried by the vessel propelling the pushed convoy or side-by-side formation.

5. Pushed convoys propelled by two pushers side-by-side shall carry the marking referred to in paragraph 4 above on the starboard pusher.

6. Any vessel, pushed convoy or side-by-side formation carrying out a transport operation involving several dangerous substances that are referred to in paragraphs 1, 2 and 3 above shall carry the marking corresponding to the substance that requires the greatest number of blue lights or blue cones.

7. Any vessel not required to carry the markings referred to in paragraphs 1, 2 or 3 above but which has been issued with an approval certificate in accordance with section 8.1.8 or a provisional certificate in accordance with section 8.1.9 of ADN which conforms to the safety provisions for vessels referred to in paragraph 1 above, may, on approaching a lock, display the markings referred to in paragraph 1 above, when it wishes to pass through the lock with a vessel required to display the markings referred to in paragraph 1 above.

8. The intensity of the blue lights prescribed in this article shall be at least equal to that of ordinary blue lights.

Article 3.15 – Marking of vessels authorized to carry more than 12 passengers with a hull length of less than 20 m

Vessels authorized to carry more than 12 passengers with a hull length of less than 20 m shall carry:

By day:

A yellow bicone in a suitable position and high enough to be visible from all directions.

Article 3.16 – Marking for ferry-boats under way

1. Ferry-boats not moving independently shall carry:

By night:

- (a) A bright white light visible from all directions, at a height of not less than 5 m;
- (b) A bright green light visible from all directions, about 1 m above the light referred to in (a) above;

By day:

A green ball at a height of not less than 6 m.

The height of the bright white light and the green ball may be reduced if the ferry-boat is of a length of less than 20 m.

2. The leading boat or float of a longitudinal cable ferry-boat shall carry, by night, not less than 3 m above the water level, a bright white light visible from all directions.

3. Ferry-boats moving independently shall carry:

By night:

- (a) A bright white light visible from all directions, as prescribed in paragraph 1 (a) above;
- (b) A bright green light visible from all directions, as prescribed in paragraph 1 (b) above;
- (c) The side lights and stern light prescribed in article 3.08, paragraphs 1 (b) and (c);

By day:

A green ball, as prescribed in paragraph 1 above.

Article 3.17 – Additional marking for vessels enjoying priority of passage

Vessels for which the competent authority has authorized priority of passage at points where it regulates the order of passage may carry, in addition to the marking prescribed in other provisions of these regulations:

By day:

A red pennant at the bow and high enough to be clearly visible.

Article 3.18 – Additional marking for vessels unable to manoeuvre

1. A vessel which is unable to manoeuvre shall, if necessary, display, in addition to the marking prescribed elsewhere in these regulations:

By night:

A swinging red light; in the case of small craft, this light may be white instead of red; or

Two red lights, about 1 m one above the other, placed in a suitable position and high enough to be visible from all directions;

By day:

A swinging red flag; or

Two black balls, about 1 m one above the other, placed in a suitable position and high enough to be visible from all directions.

2. If necessary, such vessels shall in addition give the regulation sound signal.

Article 3.19 – Marking for assemblies of floating material and floating establishments under way

Without prejudice to any special conditions which may be imposed under article 1.21, assemblies of floating material and floating establishments shall carry:

By night:

A sufficient number of bright white lights visible from all directions to show their outline.

B. MARKING WHEN STATIONARY**Article 3.20 – Marking for stationary vessels**

1. All stationary vessels except the vessels listed in articles 3.22 and 3.25 shall carry:

By night:

An ordinary white light visible from all directions and at a height of at least 3 m.

This light may be replaced by an ordinary white light at the bow and an ordinary white light at the stern, positioned at the same height on the fairway side and visible from all directions;

By day:

Only vessels stationary offshore, without direct or indirect access to the bank, a black ball in a suitable position forward and high enough to be visible from all directions.

2. A convoy stationary offshore (without direct or indirect access to the shore) shall carry:

By night:

On each vessel of the formation an ordinary white light visible from all directions, in a suitable position and at a height of at least 4 m. The total number of lights marking the barges may be limited to four, provided that the outlines of the convoy are clearly marked;

By day:

A black ball on the leading vessel of the convoy or on the outermost vessels leading the convoy and on the pusher if applicable.

3. Small craft may carry, instead of the lights prescribed by night in paragraph 1 above, an ordinary white light in a suitable position and high enough to be visible from all directions.

4. The marking prescribed in this article shall not be mandatory:

- (a) When the vessel is stationary in a waterway on which navigation is temporarily impossible or prohibited;
- (b) When the vessel is stationary alongside the bank and is sufficiently well lit from the bank;
- (c) When the vessel is stationary outside the fairway in a clearly safe situation;

- (d) For ships' boats, if stationed in the vicinity of the vessel to which they belong.

Article 3.21 – Additional marking for vessels carrying out certain transport operations involving dangerous substances

The requirements of article 3.14 shall also apply to the vessels and convoys referred to in that article when those vessels are stationary.

Article 3.22 – Marking for ferry-boats made fast at their landing stage

1. Ferry-boats not moving independently shall, when made fast at their landing stage, carry by night the lights prescribed in article 3.16, paragraph 1. In addition, the lead boat or float of a longitudinal cable ferry-boat shall carry the light prescribed in article 3.16, paragraph 2.
2. Ferry-boats moving independently in service shall, when made fast at their landing stage, carry by night the lights prescribed in article 3.16, paragraph 1. When made fast for a short time, they may also keep the lights prescribed in article 3.08, paragraph 1 (b) and (c). The green light referred to in article 3.16, paragraph 3 (b) shall be extinguished as soon as the ferry-boat is no longer in service.

Article 3.23 – Marking for assemblies of floating material and floating establishments when stationary

Without prejudice to any special conditions which may be imposed under article 1.21, assemblies of floating material and floating establishments shall carry:

By night:

A sufficient number of ordinary white lights visible from all directions to show their outlines on the fairway side.

The provisions of article 3.20, paragraph 4, are applicable.

Article 3.24 – Marking for nets or poles of stationary vessels

When vessels have nets or poles extending into the fairway or near to it, such nets or poles shall be marked:

By night:

By ordinary white lights visible from all directions in sufficient number to show their position;

By day:

By yellow floats or yellow flags in sufficient number to show their position.

**Article 3.25 – Marking for floating equipment at work
and for grounded or sunken vessels**

1. Floating equipment at work and stationary vessels carrying out work or sounding or measuring operations shall carry:

(a) On the side or sides on which the fairway is clear:

By night:

Two ordinary green lights or two bright green lights, positioned at a height of about 1 m one above the other;

By day:

Two green bicones, placed about 1 m one above the other,

and, as appropriate,

(b) On the side on which the fairway is not clear:

By night:

An ordinary red light or a bright red light, placed at the same height as the higher of the two green lights prescribed in (a) above, and of the same intensity;

By day:

A red ball, placed at the same height as the higher of the two green bicones prescribed in (a) above,

or, if the vessels have to be protected against wash,

(c) On the side or sides on which the fairway is clear:

By night:

An ordinary red light and an ordinary white light, or a bright red light and bright white light, placed about 1 m one above the other, with the red light at the top;

By day:

A flag with a red upper half and a white lower half, or two flags flown one above the other, the upper flag being red and the lower flag white,

and, as appropriate,

- (d) On the side on which the fairway is not clear:

By night:

A red light at the same height and of the same intensity as the red light prescribed in (c) above;

By day:

A red flag at the same height as the red and white flag or red flag flown on the other side.

2. The marking prescribed by day in paragraph 1 (a) and (b) above may be replaced by the following signs:

- (a) On the side or sides on which the fairway is clear, the “entry permitted” board E.1 (annex 7);

and, as appropriate,

- (b) On the side on which the fairway is not clear, the “no entry” board A.1 (annex 7), placed at the same height as the board prescribed in (a) above.

3. The marking prescribed in paragraphs 1 and 2 above shall be placed high enough to be visible from all directions.

The flags may be replaced by boards of the same colour.

4. Grounded or sunken vessels shall carry the marking prescribed in paragraph 1 (c) and (d) above. If the position of a sunken vessel prevents the marking from being placed on the vessel, it shall be placed on boats or buoys or displayed in any other appropriate manner.

5. The competent authorities may waive the obligation to carry the lights prescribed in paragraphs 1 and 2 above under (a) and (b).

Article 3.26 – Marking for anchors that may be a danger to navigation

1. When, in the cases referred to in articles 3.20 and 3.23, by night, the anchors of vessels, assemblies of floating material or floating establishments are so placed that they, their cables or chains may be a danger to navigation, the “stationary vessel” light nearest to such anchors shall be replaced by two ordinary white lights visible from all directions, about 1 m one above the other.

2. The vessels, assemblies of floating material and floating establishments shall mark each of their anchors which might be a danger to navigation:

By night:

By a float with a radar reflector bearing an ordinary white light visible from all directions;

By day:

By a yellow float with a radar reflector.

3. When the cables or anchor chains of floating equipment may be a danger to navigation, they shall be marked:

By night:

By a float with a radar reflector bearing an ordinary white light visible from all directions;

By day:

By a yellow float with a radar reflector.

III. SPECIAL MARKING

Article 3.27 – Additional marking for vessels of the supervising authorities and fire fighting and rescue vessels

Vessels of the supervising authorities may, without prejudice to the marking applicable to them under the other provisions of these regulations, display:

By day and by night:

An ordinary blue scintillating light visible from all directions.

With permission of a competent authority, this shall apply also to fire fighting vessels and rescue vessels when on their way to bring assistance.

Article 3.28 – Additional marking for vessels under way carrying out work in the waterway

Vessels under way carrying out work in the waterway or engaged in sounding or measuring operations may, without prejudice to the marking applicable to them under the other provisions of these regulations, display:

By day and by night:

A bright or ordinary yellow scintillating light visible from all directions.

The use of this marking shall be restricted to vessels having written authorization from the competent authorities.

Article 3.29 – Additional marking for protection against wash

1. Vessels, assemblies of floating material and floating establishments under way or stationary (other than those specified in article 3.25) requiring protection against wash caused by the passage of other vessels or assemblies of floating material may, without prejudice to the marking applicable to them under the provisions of the other articles of this chapter, display:

By night:

An ordinary red light and an ordinary white light, or a bright red light and a bright white light, about 1 m one above the other with the red light above, and in such a position that they are clearly visible and cannot be confused with other lights;

By day:

A flag with a red upper half and the lower half white, in a suitable position and high enough to be visible from all directions. This flag may be replaced by two flags one above the other, the upper flag red and the lower flag white. These flags may be replaced by boards of the same colour.

2. Without prejudice to the provisions of article 3.25, only the following may use the marking mentioned in paragraph 1 above:

- (a) Vessels, assemblies of floating material and floating establishments which are seriously damaged or are engaged in rescue work, and vessels unable to manoeuvre;
- (b) Vessels, assemblies of floating material and floating establishments having written authorization from the competent authorities.

Article 3.30 – Distress signals

1. When a vessel in distress needs assistance, it may display:

- (a) A flag or any other suitable object waved in a circle;
- (b) A light waved in a circle;
- (c) A flag having above or below it a ball or anything resembling a ball;
- (d) Rockets or shells throwing red stars, fired one at a time at short intervals;
- (e) A luminous signal consisting of the group ... --- ... (SOS) in Morse Code;
- (f) Flames such as may be produced by burning tar, oil, etc.;
- (g) Parachute flares or hand held flares emitting a red light;

- (h) Slow, repeated up and down movements of the arms extended on each side.
- 2. These signals replace or supplement the sound signals referred to in article 4.04.

Article 3.31 – Prohibition of boarding

- 1. If there are regulations prohibiting unauthorized persons from going on board, the prohibition shall be indicated by:

circular white boards bordered with red, with a red diagonal and a picture of an averting hand in black or, alternatively, by circular white boards bordered with red, with a red diagonal and the figure of a pedestrian in black.

The boards shall be placed on the vessel or on the gangway, as circumstances require. By derogation from article 3.03, paragraph 3, they shall be about 60 cm in diameter.

- 2. The boards shall be illuminated, as required, so as to be clearly visible at night.

Article 3.32 – Prohibition of smoking or using fires and naked light

- 1. If other regulations prohibit:

- (a) smoking;
- (b) using fires and naked light;

on board, the prohibition shall be indicated by circular white boards bordered with red, with a red diagonal and a picture of a burning match or, alternatively, by circular white boards bordered with red, with a red diagonal and a picture of a cigarette emitting smoke.

The boards shall be placed on the vessel or on the gangway, as circumstances require. By derogation from article 3.03, they shall be about 0,60 m in diameter.

- 2. By night, the boards shall be illuminated so as to be clearly visible on both sides of the vessel.

Article 3.33 – Prohibition of lateral berthing

1. If there are regulations or special requirements laid down by the competent authorities prohibiting lateral berthing near a vessel (for instance, because of the nature of its cargo) that vessel shall carry on deck, in the longitudinal axis:

A square board with a triangle below.

Both faces of the square board shall be white with a red border, and have a red diagonal from the top left to the bottom right with the letter "P" in black in the centre.

Both faces of the triangle shall be white and show in black figures the distance in metres over which berthing is prohibited.

2. By night, the boards shall be illuminated so as to be clearly visible on both sides of the vessel.

3. This article shall not apply to the vessels, pushed convoys or side-by-side formations referred to in article 3.21.

Article 3.34 – Additional marking for vessels whose ability to manoeuvre is limited

1. A vessel whose capacity to give way in accordance with the requirements of these regulations is limited when it is carrying out work or underwater operations, such as dredging or cable or buoy laying, and whose position may hinder navigation, shall carry, in addition to the marking prescribed elsewhere in these regulations:

By night:

Three bright or ordinary lights, the top and bottom lights red and the middle light white, one above the other not less than 1 m apart and high enough to be visible from all directions;

By day:

A black ball, a black bicone and a black ball, the bicone in the middle, one above the other not less than 1 m apart and high enough to be visible from all directions.

2. When the operation in which they are engaged causes an obstruction, the vessels referred to in paragraph 1 shall carry, in addition to the marking prescribed in paragraph 1:

By night:

- (a) Two bright or ordinary red lights, one above the other not less than 1 m apart, on the side or sides on which the obstruction occurs, such as to be visible from all directions;
- (b) Two bright or ordinary green lights, one above the other not less than 1 m apart, on the side or sides on which the fairway is clear, such as to be visible from all directions;

By day:

- (a) Two black balls, one above the other not less than 1 m apart, on the side or sides on which the obstruction occurs;
- (b) Two black bicones, one above the other not less than 1 m apart, on the side or sides on which the fairway is clear.

The lights, balls and bicones referred to in this paragraph shall be placed not less than 2 m from, and in no case higher than, the lower light or ball referred to in paragraph 1 of this article.

3. The provisions of this article shall not apply to floating equipment at work when stationary.

Article 3.35 – Additional marking for vessels engaged in fishing

1. A vessel engaged in drawing a trawl or other fishing gear through the water (trawler) shall carry, in addition to the marking prescribed elsewhere in these regulations:

By night:

Two bright or ordinary lights, the upper light green and the lower light white, one above the other, not less than 1 m apart and high enough to be visible from all directions, forward of the light prescribed in article 3.08, paragraph 1 (a), the upper light lower than that light and the lower light at a height above the lights prescribed in article 3.08, paragraph 1 (b) at least twice the vertical distance referred to above; however, vessels less than 50 m long shall not in this case be required to carry the light prescribed in article 3.08, paragraph 1 (a);

By day:

Two black cones, point to point, one above the other and high enough to be visible from all directions.

2. Vessels engaged in fishing other than the vessels referred to in paragraph 1 shall carry the marking prescribed in that paragraph, except for the light prescribed in article 3.08, paragraph 1 (a) and, in place of the green light:

By night:

A bright or ordinary red light, such as to be visible from all directions;

and in addition, if the fishing tackle extends more than 150 m horizontally from the vessel, in line with the tackle:

By night:

A bright or ordinary white light, at a horizontal distance not less than 2 m and not more than 6 m from the two red and white lights prescribed above and at such a height as to be neither above the white light nor lower than the lights prescribed in article 3.08, paragraph 1 (b);

By day:

A black cone, point upwards.

Article 3.36 – Additional marking for vessels used for underwater diving

1. A vessel being used for underwater diving shall carry, in addition to the marking prescribed elsewhere in these regulations:

A rigid reproduction at least 1 m high of the "A" flag of the International Code of Signals, in a suitable position and high enough to be visible from all directions by night and day.

2. Where appropriate, such vessels may carry the marking referred to in article 3.34, paragraph 1, instead of the marking prescribed in paragraph 1 above.

Article 3.37 – Additional marking for vessels engaged in minesweeping

A vessel engaged in minesweeping shall carry, in addition to the marking prescribed elsewhere in these regulations:

By night:

Three bright or ordinary green lights visible from all directions, arranged in a triangle with a horizontal base in a plane perpendicular to the axis of the vessel, the top light at or near the top of the foremast and the other lights at each end of the foremast yard;

By day:

Three black balls arranged in the manner prescribed for the lights.

Article 3.38 – Additional marking for vessels on pilotage service

A vessel on pilotage service shall carry, in addition to the marking prescribed elsewhere in these regulations:

Instead of the light prescribed in article 3.08, paragraph 1 (a), two bright or ordinary lights one above the other and visible from all directions, the top light white and the lower light red, at or near the top of the mast.

Chapter 4 SOUND SIGNALS; RADIOTELEPHONY; NAVIGATION DEVICES

Article 4.01 – General

1. When sound signals other than bells are prescribed in these regulations or any other provisions applicable, they shall be given:
 - (a) On motorized vessels, except small craft unless these are vessels with radar equipment, by means of mechanically operated sound signalling devices, placed sufficiently high that the sound signals can spread freely to the front and if possible also to the back; the signalling devices shall conform to the requirements laid down in chapter I of annex 6 of these regulations;
 - (b) On non-motorized vessels and motorized small craft whose equipment does not include a sound signalling device, by means of a suitable trumpet or horn; such sound signals shall conform to the requirements of chapter I, paragraphs 1 (b) and 2 (b), of annex 6 to these regulations.
2. The sound signals given by motorized vessels shall be accompanied by light signals synchronized with them, such light signals shall be yellow, bright and visible from all directions. This provision shall not apply to small craft or to the signal prescribed in article 6.32, paragraph 4 (a), to be given by vessels proceeding downstream and navigating by radar, or to be ringing or pealing of a bell.
3. In the case of a convoy, prescribed sound signals need to be given only by the vessel carrying the boatmaster of the convoy.
4. A bell peal shall last about four seconds. It may be replaced by the repeated striking of metal on metal over the same duration.

Article 4.02 – Use of sound signals

1. Without prejudice to the other provisions of these regulations, all vessels except the small craft referred to in paragraph 2 of this article shall, when necessary, use the signals specified in chapter III of annex 6 to these regulations.
2. Small craft proceeding alone or towing or propelling in side-by-side formation only small craft may, if necessary, give the general signals specified in chapter III A of annex 6 to these regulations.

Article 4.03 – Prohibited sound signals

1. The use of sound signals other than those mentioned in these regulations, or the use of the signals mentioned otherwise than as prescribed or permitted by these regulations, is prohibited.
2. However, for communication between vessels or between the vessel and the shore, the use of other sound signals is permitted provided that they are not liable to be confused with those mentioned in these regulations.

Article 4.04 – Distress signals

1. When a vessel in distress needs assistance, it may ring a bell or sound repeated long blasts.
2. Such signals replace or supplement the visual signals referred to in article 3.30.

Article 4.05 – Radiotelephony

1. Every radiotelephone installation carried on board a vessel shall conform to the Regional Arrangement concerning the Radiotelephone Service on Inland Waterways and shall be used in accordance with the provisions of this Arrangement. Details of these provisions are provided in the radiotelephony guide for inland navigation.

Vessels navigating in inland waterways not covered by the provisions of the above-mentioned Regional Arrangement shall carry on board a radiotelephone installation operated in accordance with the requirements of the local competent authorities.

2. Motorized vessels, excluding small craft may navigate only if they are equipped with a radiotelephone installation in proper working order for ship-to-ship, nautical information and ship-to-port-authority networks. When under way, the radiotelephone installation for the ship-to-ship and nautical information channels must be permanently in a ready-to-transmit and ready-to-receive state. The channel allocated to nautical information may only be left for a short time in order to transmit or receive information on other channels.

The radiotelephone installation shall ensure that two of these networks are monitored simultaneously.

The ship station used in the radiotelephone service for inland waterways may consist of either separate equipment for each of the service categories or equipment for combinations of several of those.

3. Ferry-boats and motorized floating equipment may only sail if they are equipped with a radiotelephone installation in proper working order. When under way, the radiotelephone installation for the ship-to-ship channel must be permanently in a ready to-transmit and ready to receive state. This channel may only be left for a short time in order to transmit or receive information on other channels. The first and the second sentence shall also apply during operation.

4. Each vessel equipped with a radiotelephone installation shall make reports on the channel allocated to the ship-to-ship network before entering blind sections, narrow channels or bridge openings and the sections determined by the competent authorities.

5. Sign B.11 (Annex 7) shall indicate that the competent authority requires the use of radiotelephone communications.

Article 4.06 – Radar

1. Vessels may not use radar and Inland ECDIS equipment which may be used for conning the vessel with overlaid radar image (Navigation Mode) unless:

- (a) they are fitted with radar equipment and, if appropriate, Inland ECDIS equipment adapted to the needs of inland navigation and a rate-of-turn indicator. This equipment shall be in proper working order and of a type approved for the needs of inland navigation in accordance with the requirements of the competent authorities concerned as well as in accordance with General technical requirements for radar equipment as set out in Part III of Appendix 7 to the annex of Resolution No. 61, "Recommendations on Harmonized Europe-Wide Technical Requirements for Inland Navigation Vessels". However, ferry-boats not moving independently shall not be required to be fitted with a rate-of-turn indicator;
- (b) a person holding a certificate of aptitude to use radar in accordance with the requirements of the competent authorities is on board. Notwithstanding the provisions of article 1.09, paragraph 3, the radar may be used for training purposes in good visibility by day and by night, even when there is no such person on board;

- (c) they are equipped with a device for emitting the three-tone signal with the exception of small craft and ferry-boats. However, the competent authorities may not prescribe such a system.

Notwithstanding the provisions of article 4.05, small craft shall also be equipped with a radiotelephone in proper working order for the ship-to-ship network.

- 2. In convoys, the requirements of paragraph 1 above shall apply only to the vessel carrying the boatmaster of the convoy.
- 3. High-speed vessels under way shall use radar.

Article 4.07 – Inland Automatic Identification System (AIS)

1. Vessels shall be equipped with Inland AIS devices in conformity with the International Standard for Tracking and Tracing on Inland Waterways (VTT) (Resolution No. 63) and ITU Radio Regulations. The Inland AIS device shall be certified and installed in conformity with the requirements of the competent authority and shall be in good working condition. The competent authority may exempt seagoing vessels from these requirements.

The following vessels shall not be subject to these requirements:

- (a) Vessels in convoys, except the vessel that provides the main propulsion;
- (b) Small craft;
- (c) Vessels without their own means of propulsion;
- (d) Ferry boats not moving independently.

2. The Inland AIS device shall be switched on at all times and the data entered in the device shall at all times correspond with the actual data relating to the vessel or convoy. This requirement does not apply to stationary vessels in berthing areas designated by the competent authorities. The vessels referred to in paragraph 1 (a) shall deactivate any Inland AIS device that is on these vessels as long as they are part of the convoy.

3. ITU Radio Regulations apply to the sending of messages via Inland AIS.

4. In accordance with chapter 2 of the International Standard for Tracking and Tracing on Inland Waterways (VTT) (Resolution No. 63) and the respective ITU Recommendation, at least the following data shall be transmitted:

- (a) User identifier (Maritime Mobile Service Identity, MMSI);
- (b) Name of vessel;
- (c) Type of vessel or convoy;

- (d) Unique European vessel identification number (ENI) or IMO number;
 - (e) Overall length of the vessel or convoy (decimetre accuracy);
 - (f) Overall beam of the vessel or convoy (decimetre accuracy);
 - (g) Position (WGS-84);
 - (h) Speed over ground (SOG);
 - (i) Course over ground (COG);
 - (j) Time of electronic position fixing device;
 - (k) Navigational status (e.g. under way using engine, at anchor, moored);
 - (l) Position acquisition point on the vessel in metre accuracy (e.g. GNSS antenna);
 - (m) Position accuracy (GNSS/DGNSS);
 - (n) Type of Electronic Positioning Fixing Device (e.g. GPS, Galileo, Glonass).
5. The boatmaster shall immediately update the following data if it has changed:
- (a) Overall length;
 - (b) Overall beam;
 - (c) Type of convoy;
 - (d) Navigational status;
 - (e) Position acquisition point on the vessel.
6. Small craft may be equipped with an Inland AIS device, a Class A AIS device, or a Class B AIS device. Inland AIS devices should be in conformity with the International Standard for Tracking and Tracing Inland Waterways (VTT) (Resolution No. 63) and radiotelephone regulations. Class A AIS devices should be in conformity with IMO regulations. Class B AIS devices should be in conformity with international telecommunications and electrotechnical regulations.
7. Small craft which do not have an ENI number are not required to transmit the data stipulated in paragraph 4 (d) above.
8. Small craft employing AIS shall also have radiotelephone equipment in good working condition and operating in receiving mode of the ship-to-ship channel.
9. For vessels using Class A AIS devices having an IMO type reception or Class B AIS devices, the requirements of paragraph 1 shall apply by analogy.

Chapter 5 WATERWAY SIGNS AND MARKING

Article 5.01 – Signs

1. Annex 7 to these regulations sets out the prohibitory, mandatory, restrictive, recommendatory and informative signs and auxiliary signs for inland waterways which are installed by the competent authorities to ensure safety and order of navigation. It also defines the meaning of each sign.
2. Without prejudice to the other provisions of these regulations or to any other provisions applicable, including the special instructions referred to in article 1.19, boatmen shall obey the rules and take account of the recommendations and information conveyed to them by the signs referred to in paragraph 1 above on the waterway or its banks.

Article 5.02 – Marking

Annex 8 to these regulations defines the marking which may be used to facilitate navigation. It also specifies the circumstances in which the various marks are to be used.

Chapter 6 RULES OF THE ROAD

I. GENERAL

Article 6.01 – Definitions and scope of application

1. For the purposes of this chapter, the following terms are used:
 - (a) "Meeting": where two vessels are proceeding on courses directly or almost directly opposite;
 - (b) "Overtaking": where a vessel (the overtaking vessel) comes up to another vessel (the vessel being overtaken) from a direction more than 22.5° abaft the latter vessel's beam and overtakes it;
 - (c) "Crossing": where two vessels are approaching in a situation other than the cases referred to under (a) and (b).
2. Unless otherwise indicated, for the purpose of this chapter, the rules applicable to vessels also apply to convoys.

Article 6.01 bis – High-speed vessels

High-speed vessels are required to leave all other vessels enough room to hold their course and to manoeuvre; they may not require such vessels to give way to them.

Article 6.02 – Small craft: General rules

1. For the purposes of this chapter, the term "small craft" means small craft navigating alone or convoys consisting only of small craft.
2. Small craft in relation to vessels other than small craft shall leave them enough room to hold their course and to manoeuvre. They may not require that such vessels give them way.

II. MEETING, CROSSING AND OVERTAKING

Article 6.03 – General principles

1. Meeting or overtaking is permitted only when the fairway is unquestionably wide enough for simultaneous passage, taking all the local circumstances and movements of other vessels into account.
2. When vessels are proceeding in convoy, the prescribed signals in articles 3.17, 6.04 and 6.10 shall be shown or emitted only by the vessel carrying the boatmaster of the convoy.
3. Vessels on courses which preclude all danger of collision shall not change their course or their speed in a manner which might give rise to danger of collision.
4. A boatmaster seeing any danger of collision shall sound a series of very short blasts.

Article 6.03 bis – Crossing

1. When two vessels are crossing in such manner that there is a risk of collision, the vessel which has the other vessel to starboard shall give way to it and, if circumstances permit, avoid crossing ahead of it. This rule shall not apply to small craft in relation to other vessels.
2. The provision in paragraph 1 shall not apply when any one of articles 6.13, 6.14 or 6.16 is applicable.
3. Notwithstanding anything to the contrary in paragraph 1 above, when, in the case of small craft of different categories, two small craft are crossing in such a manner that there is a risk of collision, motorized small craft shall give way to all other small craft and small craft neither motorized nor under sail shall give way to small craft under sail.
4. Notwithstanding anything to the contrary in paragraph 1 above, when, in the case of vessels under sail, two vessels are crossing in such a manner that there is a risk of collision, one of them shall give way to the other as follows:
 - (a) When each vessel has the wind on a different side, the vessel with the wind on the port side shall give way to the other;
 - (b) When both vessels have the wind on the same side, the vessel which is to windward shall give way to the vessel to leeward;
 - (c) If a vessel which has the wind on the port side sees another vessel to windward and cannot determine with certainty whether the other vessel has the wind on the port or on the starboard side, the first shall give way to the other.

This paragraph shall not apply to small craft in relation to other vessels.

5. By derogation from paragraphs 1, 3 and 4 above, the vessel navigating close to the boundary of a marked fairway with the boundary on its starboard side shall continue following the boundary of the fairway; the other vessel shall give way. This paragraph shall not apply to small craft in relation to other vessels.

Article 6.04 – Meeting: Normal rules

1. When two vessels are meeting and there may be a risk of collision, each vessel shall veer to starboard so as to pass on the port side of the other. This rule does not apply to small craft in relation to other vessels.

2. When meeting, vessels proceeding upstream shall, with due regard for local circumstances and the movements of other vessels, give way to vessels proceeding downstream.

3. Vessels proceeding upstream which leave the course of those proceeding downstream on their port side give no signal.

4. Vessels proceeding upstream which leave the course of those proceeding downstream on their starboard side shall in good time and to starboard:

(a) By night:

Display a bright scintillating white light in conjunction, if desired, with a light blue board;

(b) By day:

- Display a strong scintillating white light; or
- Display a light blue board in conjunction with a bright scintillating white light.

These signals shall be visible from ahead and from astern and be displayed until passing is completed. Their continued display after passing is completed is prohibited unless it is desired to indicate an intention to continue allowing vessels proceeding downstream to pass to starboard. The light blue board shall have a white border not less than 5 cm wide; the frame and lath structure and the lantern of the scintillating light shall be dark in colour.

5. As soon as it appears that the intentions of a vessel proceeding upstream may not have been understood by a vessel proceeding downstream, the vessel proceeding upstream shall sound:

- One short blast when the meeting is to be to port;
- Two short blasts when the meeting is to be to starboard.

6. Without prejudice to the provisions of article 6.05 below, vessels proceeding downstream shall follow the course indicated by those proceeding upstream in accordance with the above provisions; they shall repeat the visual signals referred to in paragraph 4 above or the sound signals referred to in paragraph 5 above made to them by vessels proceeding upstream.

7. Paragraphs 1 to 6 above shall not apply to small craft in relation to other vessels or to small craft meeting other small craft.

8. When two small craft are meeting and there may be a risk of collision, each vessel shall veer to starboard so as to pass on the port side of the other.

9. Notwithstanding anything to the contrary in paragraph 8 above, when, in the case of small craft of different categories, two small craft are meeting in such a manner that there is a risk of collision, motorized small craft shall give way to all other small craft and small craft neither motorized nor under sail shall give way to small craft under sail. However, the vessel navigating close to the boundary of a marked fairway with the boundary on its starboard side shall continue following the boundary of the fairway; the other vessel shall give way.

Article 6.05 – Meeting: Departures from normal rules

1. By derogation from the normal rule set out in article 6.04, vessels may in exceptional cases, and if certain that their request can be safely met, ask to pass starboard to starboard.

2. By derogation from the provisions of article 6.04:

- (a) Passenger vessels providing a regular service and whose authorized maximum passenger capacity is not below a number prescribed by the competent authority, when proceeding downstream and wishing to call at a landing-stage on the side used by vessels proceeding upstream; and
- (b) Towed convoys proceeding downstream which wish to keep close to a particular bank in order to turn upstream;

have the right to ask vessels proceeding upstream to change the course left clear for them in accordance with article 6.04 above if that course does not suit them.

However, they may not so ask unless certain that their request can be safely met.

3. In such cases, the vessels or convoys proceeding downstream shall give the following signals in good time:

- If they wish to pass to port, one short blast;

- If they wish to pass to starboard, two short blasts and, in addition, the visual signals referred to in article 6.04, paragraph 4.
4. Vessels or convoys proceeding upstream shall then grant the request of those proceeding downstream and confirm the fact as follows:
- If they are to pass to port, by sounding one short blast and, in addition, removing the visual signals referred to in article 6.04, paragraph 4;
 - If they are to pass to starboard, by sounding two short blasts and, in addition, displaying the visual signals referred to in article 6.04, paragraph 4.
5. As soon as it appears that the intentions of a vessel proceeding downstream may not have been understood by a vessel proceeding upstream, the vessel proceeding downstream shall repeat the sound signals referred to in paragraph 4 of this article.
6. If a vessel proceeding upstream sees that the course requested by one proceeding downstream is unsuitable and will cause a danger of collision, it shall sound a series of very short blasts. The steersmen shall then take all the steps required by the situation to obviate the danger.
7. Paragraphs 1 to 6 above shall not apply to small craft in relation to other vessels or to small craft meeting other small craft.

Article 6.06 – Meeting: High speed vessels

The provisions referred to in article 6.04 and 6.05 shall not apply in the event of a meeting between high-speed vessels and between a high-speed vessel and any other vessel. However, high-speed vessels shall agree on their meeting using radiotelephony.

Article 6.07 – Meeting in narrow fairways

1. In order to avoid so far as possible meetings on sections or at points where the fairway is not unquestionably wide enough for vessels to pass (narrow fairways), the following rules shall apply:
- (a) All vessels shall proceed through narrow fairways as quickly as possible;
 - (b) Where the view is restricted, vessels shall sound one long blast before entering a narrow fairway; if necessary, especially when the narrow fairway is long, they shall repeat this signal while passing through it;
 - (c) On waterways for which “downstream” and “upstream” are defined:
 - (i) A vessel or convoy proceeding upstream, on becoming aware that a vessel proceeding downstream is about to enter a narrow fairway, shall stop

below the fairway until the vessel proceeding downstream has passed through it;

- (ii) When a convoy or a vessel proceeding upstream has already entered a narrow fairway, vessels or convoys proceeding downstream shall, so far as possible, stop above the fairway until the convoy or vessel has passed through it;
- (d) On waterways for which “downstream” and “upstream” are not defined:
- (i) Vessels having no obstacle to starboard and those which in a curved narrow fairway have the outside of the curve to starboard shall hold their course and other vessels shall wait until they have passed through the narrow fairway; however, this provision shall not apply to small craft in relation to other vessels;
 - (ii) In the case of a meeting between a small craft under sail and a small craft of another category, the small craft under sail shall maintain its course and the other shall wait until the small craft under sail has passed through the narrow fairway;
 - (iii) In the case of two sailing vessels meeting, the vessel to windward or, if both are navigating with the wind, the vessel which has the wind on the starboard side shall maintain its course and the other vessel shall wait until it has passed through the narrow fairway.

This provision shall not apply to small sailing craft in relation to other vessels.

2. When a meeting in a narrow fairway has become inevitable, the vessels concerned shall take every possible precaution to ensure that they pass at a point and under conditions involving the minimum danger.

Article 6.08 – Meeting prohibited by waterway signs

1. On sections marked by the signs A.4 or A.4.1 (annex 7), passing and overtaking are prohibited. The prohibition referred to in the preceding sentence may be limited to vessels and convoys above a certain length or breadth; in such cases, the length or breadth is indicated on a rectangular white board fixed below the signs A.4 and A.4.1. In addition, the provisions of article 6.07, paragraph 1, apply by analogy.

2. If, in order to prevent any meeting, the competent authorities prescribe alternate one-way traffic:

- Prohibition of passage shall be indicated by a general prohibitory sign (A.1, annex 7);

- Authorization of passage shall be indicated by a general “entry permitted” sign (E.1, annex 7).

Depending on local circumstances, warning of the sign prohibiting passage may be given by the mandatory sign B.8 (annex 7) used as an advance sign.

Article 6.09 – Overtaking: General provisions

1. Overtaking is permitted only if the overtaking vessel has made certain that it can be accomplished without danger.
2. The vessel being overtaken shall facilitate overtaking insofar as it is necessary and possible. It shall slow down, if necessary, to permit overtaking to be accomplished without danger and quickly enough not to hamper the movements of other vessels.

This provision shall not apply to a small craft overtaking a vessel other than a small craft.

Article 6.10 – Overtaking

1. As a general rule, the overtaking vessel shall pass to port of the vessel being overtaken. When overtaking is possible without danger of a collision, the overtaking vessel is allowed to pass also on starboard side of the vessel being overtaken. If overtaking is possible without the vessel being overtaken changing its course or speed, the overtaking vessel need give no sound signal.
2. When overtaking is impossible without the vessel being overtaken changing course, or when it appears that the vessel being overtaken may not have noticed the intention to overtake and that this may cause a danger of collision, the overtaking vessel shall sound:
 - (a) Two long blasts followed by two short blasts if it wishes to pass to port;
 - (b) Two long blasts followed by one short blast if it wishes to pass to starboard.
3. If the vessel being overtaken can grant this request by the overtaking vessel, it shall leave the necessary space on the side requested, moving over towards the other side if necessary, and sound:
 - (a) One short blast when it is to be overtaken to port;
 - (b) Two short blasts when it is to be overtaken to starboard.
4. When overtaking is not possible on the side requested by the overtaking vessel, but possible on the other side, the vessel being overtaken shall sound:
 - (a) One short blast when overtaking is possible to port;
 - (b) Two short blasts when overtaking is possible to starboard.

If the overtaking vessel still wishes to pass, it shall then sound two short blasts in case (a) or one short blast in case (b).

The vessel being overtaken shall then leave the necessary space on the side on which it is to be overtaken, moving over to the other side if necessary.

5. When overtaking is impossible without danger of a collision, the vessel being overtaken shall sound five short blasts.

6. In the case of two sailing vessels, the overtaking vessel shall as a general rule pass on the side on which the vessel being overtaken has the wind. This provision shall not apply to a small sailing craft which is overtaken by another sailing vessel.

When a vessel is being overtaken by a sailing vessel, it shall facilitate overtaking on the side on which the overtaking craft has the wind. This provision shall not apply to a small sailing craft overtaking another vessel.

7. Paragraphs 2 to 5 above shall not apply to small craft in relation to other vessels or to small craft overtaking other small craft.

Article 6.11 – Overtaking prohibited by waterway signs

Without prejudice to the provisions of article 6.08, paragraph 1, overtaking is prohibited:

- (a) Generally on sections marked by the signs A.2 and A.4 (annex 7);
- (b) Between convoys in the areas marked by the signs A.3 and A.4.1 (annex 7). However, this prohibition shall not apply when at least one of the convoys is a pushed convoy whose maximum dimensions do not exceed 110 m by 12 m.

III. OTHER RULES OF THE ROAD

Article 6.12 – Navigation on sections where the course is prescribed

1. On sections where the course to be followed is prescribed, that course shall be marked by the mandatory signs B.1, B.2, B.3 or B.4 (annex 7). The end of the section may be indicated by the informative sign E.11 (annex 7).

2. On such a section, vessels proceeding upstream shall in no case impede the progress of those proceeding downstream; in particular, on approaching the mandatory sign B.4, they shall if necessary reduce speed or even stop to allow vessels proceeding downstream to manoeuvre.

Article 6.13 – Turning

1. Vessels may turn only after making certain that the movements of other vessels will allow them to do so safely, and without obliging such other vessels to change their course or speed abruptly.
2. If the intended manoeuvre will oblige other vessels to change their course or speed, the vessel wishing to turn shall, before turning, announce its intention in good time by sounding:
 - (a) A long blast followed by a short blast if it wishes to turn to starboard; or
 - (b) A long blast followed by two short blasts if it wishes to turn to port.
3. The other vessels shall, so far as is necessary and possible, change their speed and course to allow the turn to be made safely. In particular, when vessels wish to turn in order to head against the current, the other vessels shall help to ensure that they can do so in good time.
4. The provisions of paragraphs 1 to 3 above shall not apply to small craft in relation to other vessels. For small craft among themselves, only paragraphs 1 and 3 shall apply.
5. All turning is prohibited on sections marked with the prohibitory sign A.8 (annex 7). On the other hand, if sections of a waterway are marked with the informative sign E.8 (annex 7), boatmasters are recommended to choose such sections for turning, to which manoeuvre the provisions of this article remain applicable.

Article 6.14 – Procedure on departure

The provisions of article 6.13 above shall apply also to vessels, other than ferry-boats, when leaving their anchorage or berth without turning; however, the signals prescribed in paragraph 2 of that article shall be replaced by the following:

- (a) one short blast when the vessels are approaching on the starboard side; or
- (b) two short blasts when they are approaching on the port side.

Article 6.15 – Prohibition of entering the spaces between vessels in a towed convoy

Entering the spaces between vessels in a towed convoy is prohibited.

Article 6.16 – Harbours and tributary waterways: entering and leaving; leaving followed by crossing the waterway

1. Vessels may enter or leave a harbour or a tributary waterway or enter or cross the waterway only after making certain that they can do so safely and without obliging other vessels to change their course or speed abruptly.

If a vessel proceeding downstream is obliged to turn upstream in order to enter a harbour or tributary waterway, it shall accord priority to any vessel proceeding upstream which also wishes to enter the harbour or tributary waterway.

In certain cases, waterways considered to be tributaries may be marked by one of the signs E.9 or E.10 (annex 7).

2. If the intended manoeuvre is likely or certain to oblige other vessels to change their course or speed, vessels except ferry-boats carrying out any of the manoeuvres referred to in paragraph 1 above shall announce the manoeuvre by sounding in good time:

- Three long blasts followed by one short blast when, to enter or after leaving, they have to turn to starboard;
- Three long blasts followed by two short blasts when, to enter or after leaving, they have to turn to port;
- Three long blasts when, after leaving, they wish to cross the waterway.

Before completing the crossing, they shall, if necessary, sound:

- One long blast followed by one short blast if they wish to turn to starboard; or
- One long blast followed by two short blasts if they wish to turn to port.

3. The other vessels shall change their course and speed if necessary.

This provision shall also apply when the sign B.10 (annex 7) is placed on the main waterway near the exit from a harbour or tributary waterway.

4. If the sign B.9 (a) or B.9 (b) (annex 7) is placed near the exit from a harbour or tributary waterway, vessels leaving that harbour or waterway may enter or cross the main waterway only if their doing so will not oblige vessels proceeding on it to change their course or speed.

5. Vessels may not enter a harbour or tributary waterway when the sign A.1, together with the additional sign shown in annex 7, section II, paragraph 2 (b), is displayed on the main waterway.

Vessels may not leave a harbour or tributary waterway when the sign A.1, together with the additional sign shown in annex 7, section II, paragraph 2 (b), is near the exit.

6. If the sign E.1 together with the additional sign shown in annex 7, section II, paragraph 2 (a), is displayed on the main waterway, vessels may enter a harbour or tributary waterway even if their doing so might oblige vessels proceeding on the main waterway to change their course or speed. Vessels may leave if the sign E.1, together with the additional sign shown in annex 7, section II, paragraph 2 (a), is displayed near the exit; in this case, the sign B.10 (annex 7) shall be displayed on the main waterway.

7. The provisions of paragraphs 1 to 3 shall not apply to small craft in relation to other vessels, nor shall those of paragraph 4 apply to vessels which are not small craft in relation to small craft. The provisions of paragraph 2 shall not apply to small craft among themselves.

Article 6.17 – Sailing abreast and prohibition to approach vessels

1. Vessels may sail abreast only if there is enough room to do so without inconvenience or danger to navigation.

2. Except when overtaking or passing, it is prohibited to sail within 50 m of a vessel, side-by-side formation or pushed convoy showing the marking referred to in article 3.14, paragraphs 2 or 3.

3. Without prejudice to the provisions of article 1.20, it is prohibited to go alongside a vessel or an assembly of floating material under way, to grapple it or to ride along in its wake, without the express permission of its boatmaster.

4. Water skiers and persons practising aquatic sports without the use of a vessel shall keep at a sufficient distance from vessels and assemblies of floating material under way and from floating equipment at work.

Article 6.18 – Prohibition of trailing of anchors, cables or chains

1. The trailing of anchors, cables or chains is prohibited.

2. This prohibition does not apply to small movements at stopping places or to manoeuvring, except in the following cases:

(a) less than 100 m from a bridge, lock or weir, ferry-boat or floating equipment at work;

(b) on sections of the waterway marked with the prohibitory sign A.6 (annex 7), in accordance with the provisions of article 7.03, para. 1 (b).

3. This prohibition shall not apply either on sections marked, in accordance with article 7.03, paragraph 2, with the informative sign E.6 (annex 7).

Article 6.19 – Drifting

1. Drifting is prohibited without permission from the competent authorities.
2. This prohibition does not apply to small movements at berthing places and places of loading and unloading, insofar as safe stopping is ensured, and in harbours.
3. Vessels drifting downstream while facing upstream with engines running “ahead” are considered to be going upstream, not drifting.

Article 6.20 – Wash

1. Vessels shall regulate their speed to avoid creating excessive wash or suction likely to cause damage to stationary or moving vessels or structures. In particular, they shall reduce speed in good time, but not to below the speed required to steer safely:
 - (a) Outside harbour entrances;
 - (b) Near vessels made fast to the bank or to a landing-stage, or loading or discharging cargo;
 - (c) Near vessels lying at normal stopping places;
 - (d) Near ferry-boats which are not moving independently;
 - (e) On sections of the waterway designated by the competent authorities; such sections may be marked by the sign A.9 (annex 7).
2. Subject to the provisions of article 1.04, vessels are not required to fulfil the obligations imposed by paragraph 1 (b) and (c) above in respect of small craft.
3. When passing vessels displaying the markings prescribed in article 3.25, paragraph 1 (c), or vessels, assemblies of floating material or floating establishments displaying the markings prescribed in article 3.29, paragraph 1, other vessels shall reduce speed as prescribed in paragraph 1 above. They shall also keep as far off as possible.

Article 6.21 – Convoys

1. Motorized vessels propelling a convoy shall have sufficient power to ensure proper control of the convoy.
2. The pusher of a pushed convoy shall be capable of stopping the convoy in good time, without turning, in such a way that the convoy remains under proper control.
3. Motorized vessels may not, except for rescue or assistance to a vessel in distress, be used for towing, pushing or propelling a side-by-side formation, unless such a use is allowed in their ship's certificate. It is prohibited for motorized vessels towing or pushing

other vessels or propelling them in side-by-side formation to leave them during making-fast or anchoring operations before the fairway has been cleared of such vessels and the boatmaster of the convoy has satisfied himself that they are in a secure position.

4. Ship-borne barges shall not be placed at the head of a pushed convoy unless anchors may be presented at the head of the convoy.

5. Passenger vessel with passengers on board shall not sail as part of a convoy. This prohibition shall not apply in cases where an auxiliary towing vessel is required or in case of emergency.

Article 6.21 bis – Relocation of pushed barges outside a pushed convoy

A pushed barge outside a pushed convoy may be relocated only:

- (a) Being coupled side-by-side to a motorized vessel; or
- (b) In accordance with the regulations or with the authorization of the competent authority;
- (c) On short distances when a pushed convoy is being formed or broken up; or
- (d) Being coupled side-by-side with vessel which has a steering device and a sufficient crew.

Article 6.22 – Suspension of navigation

1. When the competent authorities announce by the general prohibitory sign A.1 a–f (annex 7) that navigation is suspended, all vessels shall stop short of that sign.

2. Navigation on waters displaying the sign:

- (a) A.1a (annex 7) is prohibited for all vessels;
- (b) A.12 (annex 7) is prohibited for all motorized vessels;
- (c) A.1g (annex 7) is prohibited for all vessels, with the exception of non-motorized small craft.

Article 6.22 bis – Navigation when passing floating equipment at work or grounded or sunken vessels, and vessels whose ability to manoeuvre is limited

It is prohibited to pass the vessels referred to in article 3.25 on the side on which they show the red light or lights prescribed in article 3.25 (b) and (d), or the board

bearing the sign A.1 (annex 7), the red ball or the red flag prescribed in article 3.25, paragraph 1 (b) and (d), or to pass the vessels referred to in article 3.34 on the side on which they show the two red lights or the two black balls prescribed in article 3.34, paragraph 2 (a).

IV. FERRY-BOATS

Article 6.23 – Rules applicable to ferry-boats

1. Ferry-boats may cross the waterway only after making certain that the movement of other vessels enables them to do so without risk and that the latter are not obliged to change their course or speed abruptly.
2. A ferry-boat which is not moving independently shall, in addition, comply with the following rules:
 - (a) When not operating, it shall lie at the berth assigned to it by the competent authority. If no berth has been assigned to it, it shall lie in such a position that the fairway remains clear;
 - (b) When the longitudinal cable of a ferry-boat may block the navigable fairway, the ferry-boat may stop on the side of the fairway opposite the point at which the cable is made fast only as long as is strictly necessary for embarking and disembarking. During these operations, approaching vessels may request the clearing of the fairway by sounding one long blast in good time;
 - (c) A ferry-boat shall not remain in the fairway longer than is necessary for the service it provides.

V. PASSAGE UNDER BRIDGES AND THROUGH WEIRS AND LOCKS

Article 6.24 – Passage under bridges and through weirs: General

1. At the opening of a bridge or weir, the rules of article 6.07 shall apply unless the fairway is wide enough for simultaneous passage.
2. When passage through the opening of a bridge or weir is authorized and the opening is marked by:
 - (a) The sign A.10 (annex 7),
navigation is prohibited outside the area between the two boards constituting this sign;

(b) The sign D.2 (annex 7),

vessels are recommended to keep within the area between the two boards or lights constituting this sign.

Article 6.25 – Passage under fixed bridges

1. When certain openings of fixed bridges are marked by:

one or more red lights or red-white-red boards (sign A.1, annex 7), such openings are prohibited for navigation.

2. When certain openings of fixed bridges are marked by:

(a) The sign D.1 (a) (annex 7), or

(b) The sign D.1 (b) (annex 7),

placed above the opening, it is recommended that these openings should be given preference.

If the fairway is marked with the sign referred to in (a) above, it is open to navigation in either direction.

If it is marked with the sign referred to in (b) above, it is closed to navigation coming from the other direction. In this case, the entrance of the other side is marked with the sign A.1 (Annex 7).

3. When certain openings of fixed bridges are marked as specified in paragraph 2 above, vessels may use the unmarked openings only at their own risk.

Article 6.26 – Passage through movable bridges

1. Without prejudice to the other provisions of these regulations and to any other provisions applicable, boatmasters shall, on approaching and passing through movable bridges, obey any instructions given to them by the bridge staff to ensure safe and orderly navigation or quick passage. The boatmaster of a vessel shall announce his intention to navigate through the bridge to the bridge operators by means of a long blast or radiotelephone.

2. On approaching a movable bridge, vessels shall reduce speed.

If they cannot or do not wish to pass through the bridge, and if boards bearing the sign B.5 (annex 7) are placed on the bank, they shall stop short of those boards.

3. Overtaking when approaching movable bridges is prohibited unless special instructions are given by the bridge staff.

4. Passage through movable bridges may be regulated by the following signals:
- (a) One or more red lights mean:
Passage prohibited;
 - (b) A red light and a green light at the same height or a red light above a green light mean:
Passage is still prohibited, but the bridge is being opened and vessels should prepare to get under way;
 - (c) One or more green lights mean:
Passage permitted;
 - (d) Two red lights one above the other mean:
The opening of the bridge for navigation is suspended;
 - (e) A yellow light placed on the bridge together with the marking referred to under (a) and (d) above means:
Passage prohibited except for vessels of reduced height; passage authorized in both directions;
 - (f) Two yellow lights placed on the bridge together with the marking referred to under (a) and (d) above mean:
Passage prohibited except for vessels of reduced height; passage prohibited in the other direction.
5. The red lights referred to in paragraph 4 above may be replaced by red-white-red boards (sign A.1, annex 7), the green lights by green-white-green boards (sign E.1, annex 7) and the yellow lights by yellow boards (sign D.1, annex 7).
6. The bridge operator is obliged to have on or near the bridge a radiotelephone device corresponding to the provisions of Article 4.05. For the entire duration of the navigation through the bridge, the radiotelephone device must remain switched on.

Article 6.27 – Passage through weirs

1. Prohibition of passage through an opening in a weir may be indicated by:
One or more red lights or red-white-red boards (sign A.1, annex 7).
2. Passage through an opening in a weir is permitted only when the opening is marked to the left and to the right by:
A sign E.1 (annex 7).

3. By derogation from paragraph 2 above, in the case of weirs with an overhead bridge, passage through an opening may also be authorized by:

A sign D.1a or D.1b (annex 7) placed on the bridge above the channel.

Article 6.28 – Passage through locks

1. Vessels approaching lock basins shall reduce speed. If they cannot or do not wish to enter the lock immediately, and if a board bearing the sign B.5 (annex 7) is placed on the bank, they shall stop short of that board.

2. In lock basins and locks, vessels equipped with a radiotelephone permitting communication on the nautical information network shall listen on the channel allotted to the lock.

3. Passage through locks shall be in the order of arrival in the lock basins. Small craft shall not be entitled to demand separate locking. They shall not enter the lock until invited to do so by the lock staff. Furthermore, when small craft are passing through at the same time as other vessels, they shall enter the lock only after the latter.

4. Overtaking in or near locks, and especially in lock basins, is prohibited.

5. In locks, anchors shall be in the fully raised position; the same shall apply in lock basins, unless the anchors are in use.

6. On entering locks, vessels shall reduce speed so as to avoid bumping against the gates or protective devices or against other vessels, assemblies of floating material or floating establishments.

7. In locks:

- (a) If limits are marked on the side-walls, vessels shall keep within those limits;
- (b) While the lock is being filled or emptied and until they are allowed to leave, vessels shall be made fast and the mooring ropes shall be so handled as to prevent bumping against the walls, gates or protective devices or against other vessels or assemblies of floating material;
- (c) Fendering devices shall be used. If they are not part of the vessel, the fenders shall be floating;
- (d) It is prohibited for vessels and assemblies of floating material to discharge or run off water onto the copings or onto other vessels or assemblies of floating material;
- (e) The use of mechanical means of propulsion is prohibited from the time the vessel is made fast until it is allowed to leave;

(f) Small craft shall keep away from other vessels.

8. In locks and lock basins it is obligatory to keep a minimum lateral distance of 10 m from the vessels or convoys carrying the marking referred to in article 3.14, paragraph 1. However, this obligation shall not apply to vessels and convoys also showing this marking nor to the vessels referred to in article 3.14, paragraph 7.

9. Vessels and convoys showing the marking referred to in article 3.14, paragraphs 2 or 3, shall be locked separately.

This provision shall not apply to dry cargo vessels as defined in ADN which carry only containers, intermediate bulk containers (IBCs), large packagings, multiple element gas containers (MEGCs), portable tanks and tank-containers as mentioned in ADN 7.1.1.18, and showing the marking referred to in article 3.14, paragraph 2. These may pass through locks with dry cargo vessels which carry only containers, intermediate bulk containers (IBCs), large packagings, multiple element gas containers (MEGCs), portable tanks and tank-containers as mentioned in ADN 7.1.1.18, and showing the marking referred to in article 3.14, paragraph 1, or with the vessels referred to in article 3.14, paragraph 7. There shall be a minimum distance of 10 m between the bow and the stern of vessels passing through locks together.

10. Vessels and convoys showing the marking referred to in article 3.14, paragraph 1 shall not be locked with passenger vessels.

11. On approaching the lock basin and on entering and leaving a lock, high-speed vessels shall move at a speed that will preclude any damage to the locks to vessels or to assemblies of floating material and that will not cause any danger for the persons on board.

12. In order to ensure safe and orderly navigation, quick passage through locks or their full use, the lock staff may give instructions supplementing or departing from the provisions of this article. Vessels in locks and lock basins shall comply with such instructions.

13. The provisions of this article also apply to any other types of crossings such as ship lifts and inclined planes.

Article 6.28 bis – Entering and leaving locks

1. Admittance to a lock shall be regulated both by day and by night by signal lights placed on one side or on both sides of the lock. Such signal lights shall have the following meaning:

(a) Two red lights one above the other:

No entry, lock out of service;

- (b) A single red light or two red lights side-by-side:
No entry, lock closed;
 - (c) Extinction of one of the two red lights side-by-side or one red light and one green light side-by-side or a red light above a green light:
No entry, lock being prepared for opening;
 - (d) A single green light or two green lights side-by-side:
Entry permitted.
2. Exit from a lock shall be regulated both by day and by night by the following signal lights:
- (a) One or two red lights: No exit;
 - (b) One or two green lights: Exit permitted.
3. The red light or lights referred to in paragraphs 1 and 2 above may be replaced by a board bearing the sign A.1 (annex 7).
- The green light or lights referred to in the same paragraphs may be replaced by a board bearing the sign E.1 (annex 7).
4. In the absence of lights and boards, it is prohibited to enter or leave locks except by express order of the lock staff.
5. The provisions of this article also apply to any other types of crossings such as ship lifts and inclined planes.

Article 6.29 – Priority of passage through locks

1. By derogation from article 6.28, paragraph 3, the following shall have priority of passage through locks:
- (a) Vessels carrying the sign described in article 3.27;
 - (b) Vessels carrying the sign described in article 3.17.
2. When vessels referred to in subparagraphs (a) and (b) above approach lock basins or are made fast in them, other vessels shall facilitate as much as possible passage by such vessels.
3. The provisions of this article also apply to any other types of crossings such as ship lifts and inclined planes.

VI. REDUCED VISIBILITY – NAVIGATION BY RADAR

Article 6.30 – General rules for navigation in reduced visibility; navigation by radar

1. In reduced visibility, all vessels shall navigate by radar.
2. Vessels under way in reduced visibility shall proceed at a safe speed as required by the reduced visibility and the presence and movements of other vessels and local circumstances. They shall use the radiotelephone to give other vessels the necessary information for safety of navigation. Small craft under way in reduced visibility may navigate only if they are also on listening watch on the ship-ship channel or on any other channel prescribed by the competent authorities.
3. When stopping because of reduced visibility, vessels shall, as far as possible, keep clear of the fairway.
4. Vessels proceeding on their course shall, when meeting another vessel, keep to the right as far as is necessary to allow passing port to port. The provisions of articles 6.04, paragraphs 4, 5 and 6 and of article 6.05 shall generally not apply in reduced visibility. However, passing starboard to starboard can also be allowed by the competent authorities when navigational conditions of particular waterways so require.
5. Towed convoys shall immediately proceed to the nearest safe berthing or anchoring areas, if a communication with visual sign, between the towed vessel and the motorized vessel, is not possible. For towed convoys proceeding downstream, navigation by radar is prohibited except for reaching the nearest safe berthing or anchoring areas. For such towed convoys provisions of article 6.33 are applicable.

Article 6.31 – Sound signals when stationary

1. In reduced visibility, vessels and floating equipment stationary in or near the fairway outside harbours or places specially designated by the competent authorities for berthing, shall be on listening watch on the ship-ship channel. As soon as they hear by radiotelephone, of the approach of other vessels, or as soon and as long as they hear from an approaching vessel one of the signals prescribed in article 6.32, paragraph 4 or article 6.33, paragraph 1 (b), they shall indicate their position by radiotelephone.
2. The provisions of paragraph 1 above shall not apply to vessels in a pushed convoy other than the pusher. In the case of a side-by-side formation, they shall apply only to one vessel in the formation. In the case of a towed convoy, they shall apply only to the towing vessel and the last vessel in the convoy.

3. This article shall also apply to vessels grounded in or near the fairway which may present a danger to other vessels.

Article 6.32 – Navigation by radar

1. When a vessel is navigating by radar, there shall be at all times in the wheelhouse a person holding a certificate required by the competent authorities for that section of the inland waterway and for the type of vessel he navigates and the certificate referred to in article 4.06, paragraph 1 (b), and a second person sufficiently conversant with this method of navigation. However if the wheelhouse is designed for radar navigation by one person, it is sufficient that the second person can, if necessary, be summoned to the wheelhouse immediately.

2. As soon as a vessel proceeding upstream observes oncoming vessels on the radar screen, or when it is approaching a sector where there might be vessels not yet visible on the screen, it shall communicate by radiotelephone to the oncoming vessels its category (for example, pushed convoy, high-speed vessel), name, direction and position, and agree with these vessels on a procedure for passing.

3. As soon as a vessel proceeding downstream observes on the radar screen a vessel whose position or course may cause a dangerous situation and which has not established contact by radiotelephone, the vessel proceeding downstream shall draw the attention of this vessel to the dangerous situation by radiotelephone and agree on a procedure for passing.

4. When radiotelephone contact cannot be established with the oncoming vessels, the vessel proceeding downstream shall:

- (a) Give the three-tone signal and repeat it as often as necessary. This provision does not apply to small craft;
- (b) Reduce speed and, if necessary, stop.

A vessel proceeding upstream shall, as soon as it hears the signals referred to in paragraph 4 (a) above or observes on the screen vessels whose position or movements might cause a dangerous situation, or when it is approaching a section where there might be vessels not yet visible on the screen:

- (c) Give one long blast and repeat this signal as often as necessary;
- (d) Reduce speed and, if necessary, stop.

5. Any vessel navigating by radar and called by radiotelephone shall reply by radiotelephone, giving its category (for example, pushed convoy, high-speed vessel), name, direction and position. It shall then agree on a passing procedure with the oncoming vessel; a small craft, however, shall only indicate on which side it is giving way.

6. In convoys the requirements of paragraphs 1–5 above shall apply only to the vessel carrying the boatmaster of the convoy.

Article 6.33 – Provisions for vessels not navigating by radar

1. In reduced visibility, vessels and convoys not navigating by radar shall immediately proceed to the nearest safe berthing or anchoring areas. The following provisions shall apply during the voyage to this berth:

- (a) As far as possible they shall proceed on the navigable side of the fairway;
- (b) Any vessel proceeding alone and any vessel carrying the boatmaster of a convoy shall sound one long blast; this signal shall be repeated at intervals of not more than one minute. Such vessels shall have a lookout forward; in the case of convoys, however, a lookout is required on the leading vessel only. The lookout shall be within sight or hearing or in communication through a voice link with the boatmaster of the vessel or convoy;
- (c) When a vessel is called by radiotelephone from another vessel it shall reply by radiotelephone, giving its category (for example, convoy, high-speed vessel, small craft), name, direction and position. It shall also state that it is not navigating by radar and that it is making for a berthing area. It shall then agree on a passing procedure with this vessel;
- (d) As soon as a vessel hears the sound signal from another vessel with which it has not been possible to establish contact by radiotelephone, it shall:
 - if it is near to a bank: keep close to that bank and, if necessary, stop there until this vessel has passed;
 - if it is not near to a bank and especially if it is crossing from one bank to another: clear the fairway as fully and as quickly as possible.

2. Ferry boats not navigating by radar shall, instead of the signal prescribed in paragraph 1 above, give as a fog-signal one long blast followed by four short blasts; this signal shall be repeated at intervals of not more than one minute.

VII. SPECIAL RULES

Article 6.34 – Special priorities

1. When meeting or crossing the course of:
 - (a) A vessel showing the marking referred to in article 3.34;
 - (b) A vessel showing the marking referred to in article 3.35,

other vessels shall give way.

2. Where a vessel of the category referred to in paragraph 1 (a) above meets or crosses the course of a vessel of the category referred to in paragraph 1 (b) above, the latter vessel give way to the former.
3. Vessels shall not approach within 1,000 m of the rear of a vessel showing the marking referred to in article 3.37.

Article 6.35 – Water skiing and similar activities

1. Water skiing and similar activities are permitted only by day and in good visibility. The competent authorities may mark the sections in which such activities are permitted or prohibited.
2. The boatmaster of the towing vessel shall be accompanied by a person responsible for the tow and for supervision of the skier and competent for those purposes.
3. Except when navigating in a fairway reserved for their exclusive use, towing vessels and water skiers shall keep at a sufficient distance from all other vessels, from the bank and from bathers.
4. The tow rope shall not be trailed unheld.

Article 6.36 – Conduct of, and in respect of, fishing vessels

1. Trawling with several vessels abreast is not permitted.
2. Setting of fishing equipment in or near a fairway and on berthing areas is not permitted.
3. All vessels are prohibited from passing at a short distance behind a vessel engaged in fishing showing the marking prescribed in article 3.35.

Article 6.37 – Conduct of, and in respect of, underwater divers

1. Underwater diving shall be prohibited, without a special permission, in areas where navigation might be hindered, particularly:
 - (a) On the normal course of vessels showing the marking referred to in article 3.16;
 - (b) At entrances to and in harbours;
 - (c) Near and on berthing areas;
 - (d) In areas reserved for water skiing or similar activities;

(e) On fairways;

(f) In ports.

2. All vessels shall keep at a sufficient distance from a vessel showing the marking referred to in article 3.36.

Chapter 7 BERTHING RULES

Article 7.01 – General principles of berthing

1. Without prejudice to the other provisions of these regulations, vessels and assemblies of floating material shall choose their berths as near the bank as their draught and local conditions permit and, in any case, so as not to obstruct navigation.
2. Except under special conditions laid down by the competent authorities, floating establishments shall be so placed as to leave the fairway clear for navigation.
3. Vessels, assemblies of vessels and of floating material and floating establishments shall, when stationary, be anchored or made fast in such a way that they cannot change position and thus constitute a danger or obstruction to other vessels taking into account, in particular, the wind, changes in the water level, suction and wash.

Article 7.02 – Berthing

1. Vessels, assemblies of floating material or floating establishments may not berth:
 - (a) In sections of the waterway where berthing is generally prohibited;
 - (b) In sectors designated by the competent authorities;
 - (c) In sectors marked by the sign A.5 (annex 7); the prohibition then applies on the side of the waterway on which the sign is placed;
 - (d) Under bridges and high-voltage electric lines;
 - (e) In or near narrow fairways within the meaning of article 6.07 or in or near sectors which would become narrow fairways if vessels berthed there;
 - (f) At the entrances to or exits from tributary waterways and ports;
 - (g) On the course of ferry-boats;

- (h) On the course taken by vessels to come alongside or leave a landing stage;
- (i) In turning areas marked by the sign E.8 (annex 7);
- (j) Laterally to a vessel carrying the sign prescribed in article 3.33 within the distance in metres indicated in the white triangle on that sign;
- (k) On stretches of water marked by the sign A.5.1 (annex 7) whose breadth, measured from the sign, is shown in metres on the sign;
- (l) Unless permitted by the competent authorities, in lock basins.

2. In sections where berthing is prohibited under the provisions of paragraph 1 (a) to (d) above, vessels, assemblies of floating material and floating establishments may berth only in berthing areas marked by one of the signs E.5 to E.7.1 (annex 7) and under the conditions laid down in articles 7.03 to 7.06 below.

Article 7.03 – Anchoring and use of telescopic piles (spuds)

1. Vessels, assemblies of floating material or floating establishments may not anchor:
 - (a) In sections of the waterway where anchoring is generally prohibited;
 - (b) In sectors marked by the sign A.6 (annex 7); the prohibition then applies on the side of the waterway on which the sign is placed.
2. In sections where anchoring is prohibited under the provisions of paragraph 1 (a) above, vessels, assemblies of floating material and floating establishments may anchor only in sectors marked by the sign E.6 (annex 7) and only on the side of the waterway on which the sign is placed.
3. The competent authority may extend the application of paragraphs 1 and 2 to telescopic piles (spuds).
4. In case this article is extended to the use of spuds, in sections where anchoring is prohibited under the provisions of paragraph 1 (a) and (b) above, vessels, assemblies of floating material and floating establishments may use spuds only in sectors marked by the sign E.6.1 (annex 7) and only on the side of the waterway on which the sign is placed.

Article 7.04 – Making fast

1. Vessels, assemblies of floating material or floating establishments may not make fast to the bank:
 - (a) In sections of the waterway where making fast is generally prohibited;
 - (b) In sectors marked by a sign A.7 (annex 7); the prohibition then applies on the side of the waterway on which the sign is placed.
2. In sections where making fast to the bank is prohibited under the provisions of paragraph 1 (a) above, vessels, assemblies of floating material and floating establishments may make fast only in sectors marked by the sign E.7 (annex 7) and only on the side of the waterway on which the sign is placed.
3. It is prohibited to use trees, railings, posts, marker stones, pillars, metal steps, handrails, etc., for making fast or warping.

Article 7.05 – Berthing areas

1. In berthing areas marked by the sign E.5 (annex 7), vessels and assemblies of floating material may berth only on the side of the waterway on which the sign is placed.
2. In berthing areas marked by the sign E.5.1 (annex 7), vessels and assemblies of floating material may berth only on the stretch of water whose breadth is shown in metres on the sign. This breadth shall be measured from the sign.
3. In berthing areas marked by the sign E.5.2 (annex 7), vessels and assemblies of floating material may berth only on the stretch of water bounded by the two distances shown in metres on the sign. These distances shall be measured from the sign.
4. In berthing areas marked by the sign E.5.3 (annex 7), vessels and assemblies of floating material may not, on the side of the waterway on which the sign is placed, berth abreast in a number greater than that shown in Roman figures on the sign.
5. In berthing areas, vessels shall, in the absence of instructions to the contrary, berth abreast from the bank outwards, on the side of the waterway on which the sign is placed.

Article 7.06 – Berthing authorized for certain types of vessels

In berths displaying one of the signs E.5.4 to E.5.15 (annex 7), berthing shall be authorized only for the types of vessel for which the sign is valid, and only on the side of the waterway on which the sign is placed.

Article 7.07 – Berthing in case of transport operations involving dangerous substances

1. The minimum distance to be left between two vessels, pushed convoys or side-by-side formations when berthed shall be:
 - (a) 10 m if one of them shows the marking referred to in article 3.14, paragraph 1;
 - (b) 50 m if one of them shows the marking referred to in article 3.14, paragraph 2;
 - (c) 100 m if one of them shows the marking referred to in article 3.14, paragraph 3.
2. The obligation referred to in paragraph 1 (a) above shall not apply to:
 - (a) Vessels, pushed convoys and side-by-side formations also carrying this marking;
 - (b) Vessels not carrying this marking but issued with a certificate of approval in accordance with paragraph 8.1.8 of ADN, and conforming to the safety requirements applicable to vessels referred to in article 3.14, paragraph 1.
3. The competent authority may make exceptions with regard to berthing in particular cases.

Article 7.08 – Watch and surveillance

1. An efficient watch shall be kept continuously on board of vessels lying in the fairway.
2. An efficient watch shall be kept continuously on board stationary vessels carrying the markings provided for in article 3.14. However, the competent authorities may exempt vessels berthed in harbour basins from this requirement.
3. An efficient watch shall be kept continuously on board of passenger vessels while passengers are on board.
4. All other berthed vessels, assemblies of floating material and floating installations shall be kept under surveillance by a person capable of acting quickly if the need arises, unless such surveillance is rendered unnecessary by local conditions or is waived by the competent authorities.
5. When the vessel has no boatmaster, the responsibility for setting up such a watch or surveillance shall lie with the operator and, in case the operator is not identifiable, with the owner.

Chapter 8 SIGNALLING AND REPORTING REQUIREMENTS

Article 8.01 – “Do not approach” signal

1. In case of incidents or accidents that may result in leakage of the dangerous substances carried, the ‘Do not approach’ signal shall be given by vessels carrying the markings referred to in paragraphs 1, 2 or 3 of article 3.14, if the crew cannot avert the attendant danger to human life or navigation.

This provision does not apply to pushed barges and other non-self-propelled vessels. Nevertheless, if they are part of a convoy, the ‘Do not approach’ signal shall be given by the vessel with the convoy boatmaster on board.

2. The ‘Do not approach’ signal consists of a sound signal and a light signal. The sound signal is made up of one short and one long sound which are constantly repeated for no less than 15 consecutive minutes.

The light signal, referred to in article 4.01, paragraph 2, shall be given simultaneously with the sound signal.

After being activated, the ‘Do not approach’ signal shall be emitted automatically; the control device shall be set up in such a way as to make it impossible for the signal to be activated unintentionally.

3. Vessels detecting a ‘Do not approach’ signal shall take all possible measures to avert the threat to them. In particular, they shall:

- (a) If moving towards the dangerous area, keep as far away from it as possible and, if need be, make a turn;
- (b) If past the dangerous area, continue under way at the highest possible speed.

4. On board the vessels referred to in paragraph 3 above it shall be imperative immediately to:

- (a) Close all windows and openings to the outside;
- (b) Extinguish all unprotected fire and naked lights;
- (c) Stop smoking;
- (d) Stop all unessential auxiliary machinery;
- (e) Avoid creating sparks.

If the vessel is stationary, all engines and auxiliary machinery shall be stopped or unplugged.

5. Paragraph 4 applies also to vessels berthed close to the dangerous area. Upon detecting a 'Do not approach' signal, the crew shall leave such vessels, if necessary.

6. When taking the action referred to in paragraphs 3 to 5, current and wind direction shall be taken into account.

7. The action prescribed in paragraphs 3 to 6 above shall also be taken by vessels if a "Do not approach" signal is emitted from the shore.

8. Boatmasters receiving a "Do not approach" signal shall do their utmost to report it without delay to the closest competent authority.

Article 8.02 – Reporting requirements

1. Boatmasters of the following vessels and convoys shall, prior to entering the sectors, traffic control posts, traffic centres and locks indicated by the competent authority, eventually by B.11 sign (annex 7), report their presence on the indicated radiotelephone channel:

- (a) Vessels and convoys carrying dangerous goods in accordance with the provisions of ADN;
- (b) Vessels transporting more than 20 containers;
- (c) Passenger vessels except for day-trip vessels;
- (d) Seagoing vessels, except for pleasure crafts;
- (e) Special transport referred to in article 1.21;
- (f) Other vessels and convoys as required by the competent authorities.

2. The boatmasters mentioned in paragraph 1 shall communicate the following data:

- (a) category of vessel;

- (b) name of vessel;
- (c) position, direction of navigation;
- (d) unique European vessel identification number or official number; for seagoing vessels: IMO number;
- (e) maximum load; for seagoing vessels: deadweight tonnage;
- (f) length and breadth of vessel;
- (g) type, length and breadth of convoy;
- (h) draught (only on special request);
- (i) route;
- (j) loading port;
- (k) unloading port;
- (l) nature and quantity of cargo (for dangerous goods: as required under 5.4.1.1.1 (a)-(d) and (f) and 5.4.1.2.1 (a) of the Regulations annexed to ADN for carriage in bulk or in packages, or 5.4.1.1.2 (a)-(e) of the Regulations annexed to ADN for carriage in tank-vessels);
- (m) signalization required for the carriage of dangerous goods;
- (n) number of persons on board;
- (o) number of containers on board.

3. The data given in paragraph 2 above, except those in (c) and (h), may be communicated by other services or persons to the competent authority either in writing, or by telephone or if possible electronically. In all cases, the boatmaster shall report when his vessel or convoy enters the sector subject to the reporting requirement and when it leaves the sector again.

4. When a vessel's journey is interrupted in the sector subject to the reporting requirement for more than two hours, the boatmaster shall report the beginning and end of the interruption.

5. When the data covered by paragraph 2 above change during the journey through the sector subject to the reporting requirement, the competent authority shall be notified immediately.

6. The competent authority shall not transmit these data to third parties with the exception of the neighbouring competent authorities along the vessel's route. However, in the event of an accident, the competent authority is allowed to communicate data essential for emergency rescue operations to the emergency services.

Chapter 9 REGIONAL AND NATIONAL SPECIAL REQUIREMENTS

Article 9.01 – Regional and national special requirements

1. The competent authorities may omit, complement or modify the provisions of Chapters 1-8 and, in particular, the provisions listed in this Chapter, when this is required by the conditions of navigation. In this case, they shall report on these differences to the Working Party on Inland Water Transport (SC.3).
2. The competent authorities shall also report to the Working Party on the additional local requirements existing in their region.

Article 9.02 – Chapter 1, “GENERAL PROVISIONS”

1. With respect to article 1.01, section I, para. 5, the competent authorities may state in the ship’s certificate that the vessel is a high-speed vessel.
2. With respect to article 1.01, section I, para. 10, the competent authorities may use the term “small size craft” as a subcategory of “small craft”.
3. With respect to article 1.01, section I, para. 11, the competent authorities may use a different definition of “water bike”.
4. With respect to article 1.02, the competent authorities may waive the provisions of the article in case of certain assemblies of floating material and non-motorized vessels in certain side-by-side formations.
5. With respect to article 1.09, the competent authorities may prescribe other provisions concerning age for steering small craft.
6. With respect to article 1.10 para. 1, the competent authorities may require additional documents to be on board of the vessel, including but not limited to:
 - (a) Certificate on the release of the logbooks;

- (b) Certificate of installation and functioning of tachograph and its records as required;
- (c) Radar certificate;
- (d) Certificate confirming installation and functioning of radar device and turn-and-bank indicator;
- (e) Radiotelephone certificate delivered according to the relevant international and regional agreements;
- (f) Certificate on frequency allocation;
- (g) Handbook on radiotelephony in inland navigation, (general part and regional part);
- (h) A duly completed book of oil control;
- (i) Certificate for boilers and auxiliaries for vessels;
- (j) Certificate for liquefied gas installations;
- (k) Certificate for electrical equipment;
- (l) Verification certificate for portable fire extinguishers and fixed fire extinguisher installations;
- (m) Verification certificate for cranes;
- (n) The certificate referred to in sections 8.1.2.1, 8.1.2.2 and 8.1.2.3 of ADN;
- (o) Certificate confirming stability for the transport of containers;
- (p) Certificate on duration and local boundary of the construction site, where the worksite craft is allowed to be used;
- (q) Copies of certificates for engines, including the type-approval document and the engine parameter protocol;
- (r) Certificates for mooring cables;
- (s) Certificate confirming installation and functioning of the inland AIS equipment.

Article 9.03 – Chapter 2, “MARKS AND DRAUGHT SCALES ON VESSELS; TONNAGE MEASUREMENT”

With respect to article 2.02, the competent authorities may prescribe other provisions for small craft which are neither motorized nor sailing craft and for sailboards or small sailing craft less than 7 m long.

**Article 9.04 – Chapter 3, “VISUAL SIGNALS (MARKING)
ON VESSELS”**

1. With respect to section II of Chapter 3, the competent authorities may decide not to require vessels under way to carry day markings.
2. With respect to article 3.08 para. 1, the competent authorities may:
 - (a) prescribe other stern lights;
 - (b) prescribe a height of less than 5 meters prescribed in paragraph (a).
3. With respect to article 3.09 paragraph 1 (a), the competent authorities may prescribe a height of less than 5 meters.
4. With respect to article 3.10 para. 1, the competent authorities may:
 - (a) Prescribe the use of bright lights on narrow waterways;
 - (b) Authorize the pusher to carry the masthead lights and the side lights.
5. With respect to article 3.11, the competent authorities may consider a side-by-side formation whose greatest dimensions do not exceed 110 m in length and 23 m in width as single motorized vessels.
6. With respect to article 3.14:
 - (a) In the case of seagoing vessels operating only temporarily in inland navigation areas, the competent authorities may authorize the use of the day and night signals prescribed in the Recommendations on the Safe Transport of Dangerous Cargoes and Related Activities in Port Areas adopted by the Maritime Safety Committee of the International Maritime Organization (by night an all-round fixed red light and by day flag “B” of the International Code of Signals), instead of the signals prescribed in paragraphs 1–3 of this article;
 - (b) The competent authorities may prescribe red lights (or cones) instead of blue lights (or cones).
7. With respect to article 3.16, the competent authorities may prescribe another marking.
8. With respect to article 3.20 paragraph 4, the competent authorities may prescribe that small craft other than ship’s boats does not need to carry the black ball by day.
9. With respect to article 3.27, the competent authorities may prescribe a yellow scintillating light instead of the blue for fire-fighting and rescue vessels.

Article 9.05 – Chapter 4, “SOUND SIGNALS; RADIOTELEPHONY; NAVIGATION DEVICES”

1. With respect to article 4.05, the competent authorities of some UNECE member States apply the harmonized national technical and operational requirements for radiotelephone installations on board inland navigation vessels in the framework of a Regional Arrangement based on the Radio Regulations of the International Telecommunication Union (ITU).
2. With respect to article 4.06, the competent authorities may allow on certain inland waterways high-speed vessels to operate in daytime and at a visibility of 1 km and more without being fitted with radar equipment and a rate-of-turn indicator.
3. With respect to article 4.07, the competent authorities may waive the requirement to use Inland AIS or allow exceptions restricting the use of Inland AIS to certain sectors, e.g. berthing places along the fairway.
4. With respect to article 4.02, the competent authorities may prescribe that the signal used for “Do not approach”, consisting in one short and one long blasts, repeated, as described in chapter III of Annex 6, has a different meaning.

Article 9.06 – Chapter 5, “WATERWAY SIGNS AND MARKING”

With respect to article 5.01 para.2, the competent authorities may, where necessary, regulate navigation on certain sections by also using special signs at control posts.

Article 9.07 – Chapter 6, “RULES OF THE ROAD”

1. With respect to article 6.02, the competent authorities may prescribe specific rules applicable to small size craft.
2. With respect to article 6.04, the competent authorities may prescribe special exceptions to the rules on the meeting of the vessels.
3. With respect to article 6.05, the competent authorities may prescribe special rules for the meeting of the vessels.
4. With respect to article 6.08, the competent authorities may prescribe that, if the signs referred to in paragraph 2 above cannot be displayed, vessels shall stop and wait until authorization to proceed is given by representatives of the competent authorities.
5. With respect to article 6.11 paragraph (b), the competent authorities may also stipulate an exception for the situation when one of the convoys is a side-by-side formation whose maximum dimensions do not exceed 110 m x 23 m.

6. With respect to article 6.22 bis, the competent authorities may prescribe special rules for navigation when passing floating equipment at work or grounded or sunken vessels, and vessels whose ability to manoeuvre is limited.
7. With respect to article 6.23 paragraph 2 (b), the competent authorities may prohibit the use of longitudinal cable.
8. With respect to article 6.24—6.26, the competent authorities may prescribe special rules for the passage under bridges.
9. With respect to article 6.27, the competent authorities may prescribe special rules for the passage through weirs.
10. With respect to article 6.28, the competent authorities may prescribe special rules for the passage through locks.
11. With respect to article 6.28 bis, the competent authorities may prescribe special rules for entering and leaving locks.
12. With respect to article 6.30, the competent authorities may prescribe other general rules for navigation in reduced visibility.
13. With respect to article 6.32, the competent authorities may:
 - (a) waive the provision on giving the three-tone signal or apply it only on certain waterways;
 - (b) Prescribe additional provisions for vessels navigating by radar.
14. With respect to article 6.33, the competent authorities may prescribe that a vessel carrying the boatmaster of a convoy shall sound two long blasts.

Article 9.08 – Chapter 7, “BERTHING RULES”

(left void)

Article 9.09 – Chapter 8, “SIGNALLING AND REPORTING REQUIREMENTS”

With respect to article 8.02 paragraph 4, the competent authorities may require that, if the vessel has stopped, all engines and auxiliary machinery must be stopped or unplugged.

Chapter 10 PREVENTION OF POLLUTION OF WATER AND DISPOSAL OF WASTE GENERATED ON BOARD VESSELS

Article 10.01 – Meaning of certain terms

For the purposes of this chapter, the terms set out below have the following meaning:

1. General terms:

- (a) “waste generated on board”: substances or articles defined in (b) to (f) below, of which the person in charge disposes or of which he/she intends or is required to dispose;
- (b) “wastes generated from the operation of the vessel”: wastes and waste water generated on board from the operation and maintenance of the vessel; this includes oily and greasy wastes and other wastes generated from the operation of the vessel;
- (c) “oily and greasy waste occurring from the operation of the vessel”: used oil, bilge water and other oily and greasy waste such as used grease, used filters, used rags, containers and receptacles for such wastes;
- (d) “used oil”: used oil or other non-reusable oil from engines, gears and hydraulic equipment;
- (e) “bilge water”: oily water from the engine room bilges, peak, cofferdams, double-hull spaces or side compartments;
- (f) “used grease”: used grease collected from run off from greasers, bearings and greasing facilities and other non-reusable grease;

- (g) "other wastes occurring from the operation of the vessel": domestic waste water, household refuse, sludge, slops and other special wastes within the meaning of paragraph 2 below;
- (h) "cargo related wastes": waste and waste water occurring on board the vessel and deriving from the cargo; residual cargo and handling residues as defined in (i) – (j) below are not included in this category;
- (i) "residual cargo": liquid cargo remaining in the cargo tanks or in the cargo piping after unloading without the use of a stripping system in accordance with the ADN, as well as dry cargo remaining in the holds after unloading before manual or mechanical sweepers or suction facilities are used;
- (j) "handling residues": cargo which falls on the vessel outside the hold during handling;
- (k) "reception facility": a vessel or a facility on land approved by the competent authorities for the collection of waste occurring on board.

2. Other terms

- (a) "household refuse": on board organic and inorganic household waste and food remains generated from the operation of the vessel, except for the components of the other types of waste defined in article 10.01 above;
- (b) "sludge": residues occurring on board the vessel during the operation of an on board sewage plant;
- (c) "slops": a mixture of cargo residues with swilling out water, rust or mud, whether or not suitable for pumping;
- (d) "other special waste": waste generated from the operation of the vessel other than oily and greasy waste and other than the waste covered by (a) to (c) above.

Article 10.02 – Obligation to observe regional requirements

When applying the provisions contained in this chapter, the provisions on water protection and disposal of waste in effect for the waterway concerned must also be applied.

Article 10.03 – General obligation to exercise vigilance

The boatmaster, other crew members and other persons on board shall exercise every care required by the circumstances in order to avoid polluting the waterway and to restrict to the maximum the amount of waste generated on board and to avoid as far as possible any mixing of the various categories of waste.

Article 10.04 – Prohibition on discharging and dumping

1. From the vessel, it shall be prohibited to throw, discharge or allow to run into the waterway oily or greasy wastes generated from the operation of the vessel; slops, household refuse, sludge or other special waste; portions of the cargo or cargo-related waste.

2. Exceptions to this prohibition are admissible only if consistent with the provisions on water protection and disposal of waste generated on board vessels in effect for the waterway concerned.

3. Without prejudice to the provisions on water protection and disposal of waste generated on board vessels in effect for the waterway concerned, in the event of the accidental discharge of waste referred to in paragraph 1 above or the threat of such discharge, the boatmaster must notify the nearest competent authority without delay and, as far as possible, vessels located in the vicinity of the position of the discharge, indicating as precisely as possible the position, quantity and nature of the wastes, and measures taken.

Article 10.05 – On board collection and processing of waste

1. The boatmaster shall ensure the separate collection on board of the waste referred to in article 10.04, paragraph 1 above, not including any parts of the cargo or cargo-related waste, in receptacles intended for this purpose, and the collection of bilge water in the engine room bilges. The receptacles shall be stored on board in such a way as to facilitate the timely detection and repair of any leakage of the contents.

2. It shall be prohibited:

- (a) to use mobile tanks stored on the deck for the collection of used oil;
- (b) to burn waste on board;
- (c) to introduce oil or grease dissolving or emulsifying cleaning agents into the engine room bilges except for products which do not make the treatment of bilge water by the reception facilities more difficult.

Article 10.06 – Used-oil log, deposit at reception facilities

1. All motorized vessels shall carry on board a valid used oil log issued by a competent authority and in line with the model contained in annex 9. Following its renewal, the previous log must be kept on board for at least six months after the last entry made. Exceptions are admissible only if consistent with the provisions on water protection and disposal of waste generated on board vessels in effect for the waterway concerned.
2. The oily and greasy wastes generated from the operation of the vessel, slops and other special waste shall be delivered, against a receipt, to the reception facilities at regular intervals, depending on the condition and operation of the vessel. The receipt shall consist of an entry in the used oil log by the reception facility.
3. Any vessel carrying on board other documents concerning the deposit of waste generated from the operation of the vessel shall be able to provide proof by means of other documents that the waste has been deposited. Such proof may also be furnished by the oil record book as provided for by the International Convention for the Prevention of Pollution by Ships (MARPOL 73).
4. Household refuse and sludge shall be deposited at reception facilities specially designated for this purpose.

Article 10.07 – Obligation to exercise vigilance during filling operations

1. For bunkering motorized vessels excluding small craft must use bunker boats, bunker stations or tank trucks specially designated by the competent authorities.
2. During filling operations involving fuel or lubricating oil, the boatmaster shall ensure that:
 - (a) the receiving vessel is secured in such a way that no strain is exerted on the pipes and hoses during the entire filling operation;
 - (b) the amount to be supplied is within the readable indicators of the capacity-gauging device;
 - (c) when tanks are filled individually, the shut-off valves located in the connecting piping between the tanks are closed;
 - (d) the filling operation is supervised; and

- (e) fuel tanks shall be safeguarded against fuel spills during bunker by means of appropriate onboard technical devices which shall be entered in item 52 of the ship's certificate. If fuel is taken on from bunker stations with their own technical devices to prevent fuel spills on board during bunkering, these equipment requirements shall no longer apply.

3. In addition, the boatmaster shall ensure that, before starting the filling operation, the bunker station, bunker boat or tank truck supervising person and vessel crew member responsible for the filling operation have filled in and signed a checklist (in two copies) and agreed on the following:

- (a) The automatic shut-off device (if any) is in proper working order;
- (b) A safe and direct way of communication;
- (c) The quantity to be supplied to each tank and the filling rate, in particular, with regard to possible problems with the tank ventilation systems;
- (d) The order in which the tanks are to be filled;
- (e) The speed of navigation in case of filling when under way.

An example of the checklist is included in annex 11.

4. The boatmaster and supervising person of the bunker station, bunker boat or tank truck are authorized to start the filling operation only after agreement has been reached on the points set forth in paragraph 3 above.

5. The supervising person of the bunker station, bunker boat or tank truck must interrupt the filling immediately if the supervisor on board of the receiving vessel is leaving the filling location or a safe and direct way of communication is no longer guaranteed.

6. The checklist must be stored for a minimum of six months by the receiving vessel and bunker station, bunker boat or tank truck. The competent authority is allowed to inspect the checklists.

Article 10.08 – Collection, deposit and reception of cargo-related waste

All vessels shall carry on board for each unloading operation a valid unloading certificate in accordance with the model contained in the provisions on water protection and disposal of waste generated on board vessels in effect for the waterway concerned. Unless otherwise stipulated in these provisions, the certificate must be kept on board for at least six months following the date of its issuance.

Article 10.09 – Painting and external cleaning of vessels

1. It shall be prohibited to oil or clean the outside of vessels with products which may not be discharged into water.
2. It is prohibited to use anti-fouling systems containing one or more of the following substances:
 - (a) Mercury compounds;
 - (b) Arsenic compounds;
 - (c) Organotin compounds which act as biocides;
 - (d) Hexachlorocyclohexane.

As an interim measure, pending complete removal and replacement of an anti-fouling system containing substances indicated above, it shall be permitted to apply to a vessel's hull a coating to inhibit the introduction into the water of the aforementioned substances from the anti-fouling systems under the coating.

**Annex 1
DISTINGUISHING LETTER OR GROUP OF LETTERS
INDICATING COUNTRY OF VESSELS' HOME PORT
OR PLACE OF REGISTRATION**

| | | | |
|------------------------|------------|---------------------|------------|
| AUSTRIA | A | MALTA | MLT |
| BELARUS | BY | NETHERLANDS | N |
| BELGIUM | B | NORWAY | NO |
| BOSNIA AND HERZEGOVINA | BIH | POLAND | PL |
| BULGARIA | BG | PORTUGAL | P |
| CROATIA | HR | REPUBLIC OF MOLDOVA | MD |
| CZECH REPUBLIC | CZ | ROMANIA | R |
| FINLAND | FI | RUSSIAN FEDERATION | RUS |
| FRANCE | F | SERBIA | SRB |
| GERMANY | D | SLOVAKIA | SK |
| HUNGARY | HU | SLOVENIA | SLO |
| ITALY | I | SWEDEN | SE |
| LITHUANIA | LT | SWITZERLAND | CH |
| LUXEMBOURG | L | UKRAINE | UA |

Annex 2 DRAUGHT SCALES ON INLAND WATERWAY VESSELS

1. Draught scales shall be graduated in units not larger than 1 decimetre, from the light water-line to the maximum draught level, in the form of clearly visible bands painted alternately in two different colours.

The graduation shall be indicated by figures painted beside the scale not more than 5 decimetres apart and at the top of the scale; and the position of the intervals shall be fixed and punched, incised or welded marks.

2. If the vessel bears tonnage scales meeting the requirements of paragraph 1 above, such tonnage scales may serve instead of draught scales.

Annex 3

VISUAL SIGNALS (MARKING) ON VESSELS

I. GENERAL

- 1.1 The sketches which follow relate to the signals (marking) provided for in the articles of chapter 3 of CEVNI.
- 1.2 The sketches of this annex are for guidance only; reference should be made to the text of the regulations which alone is authoritative.

In the case of additional markings which may be prescribed, the sketches illustrate:





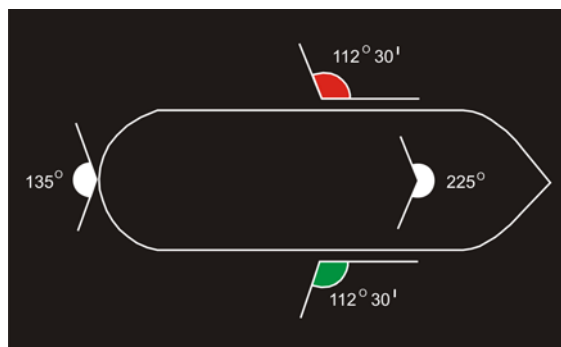

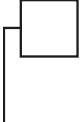
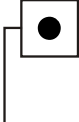

- either the additional markings alone; or
- where necessary for clarity, both the basic marking (or one of the possible basic markings) and the additional marking.

Only the additional marking is described below the sketch.

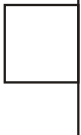
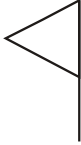

Article 3.01, paragraph 1: The horizontal arc along which the masthead light, the side lights and the stern light are visible.

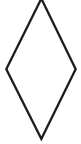
1.3 Explanation of symbols:

- a  Fixed light visible from all directions (a light projecting an uninterrupted beam throughout a horizontal arc of 360°)
- b  Fixed light visible over a limited horizontal arc. A light which is invisible to the observer is marked by a dot in the centre 
- c  Scintillating light
- d  Optional light
- e  Board or flag (article 3.03)
- f  Pennant (article 3.03)
- g  Ball (article 3.04)
- h  Cylinder (article 3.04)
- i  Cone (article 3.04)
- j  Bicone (article 3.04)
- k  Radar reflector

II. MARKING WHEN UNDER WAY

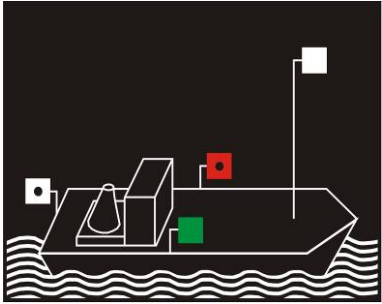
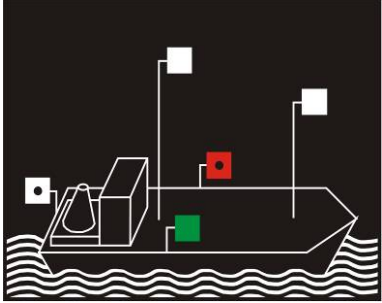
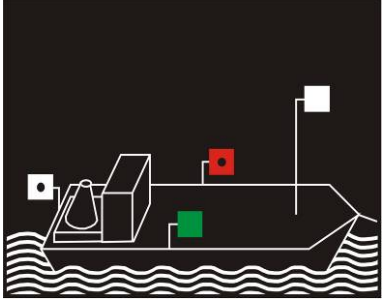
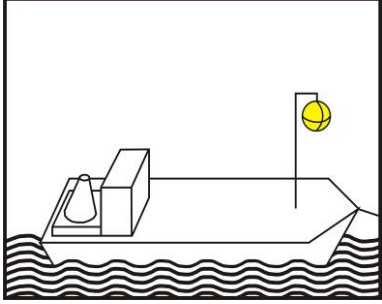

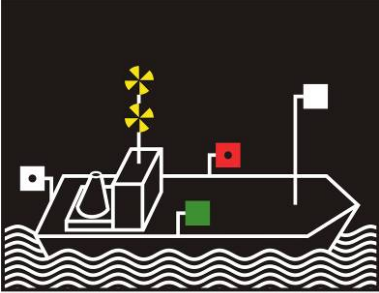
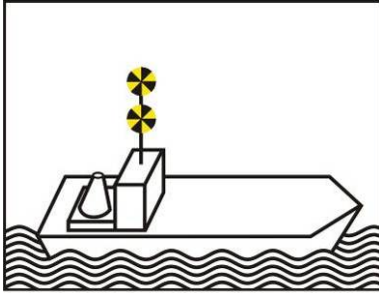
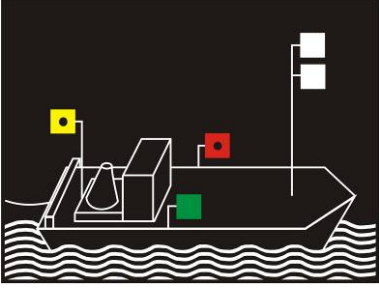
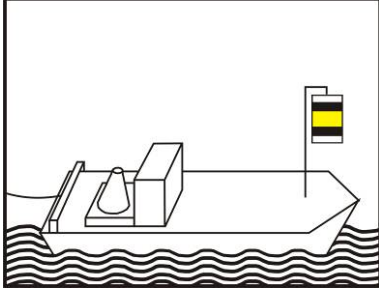
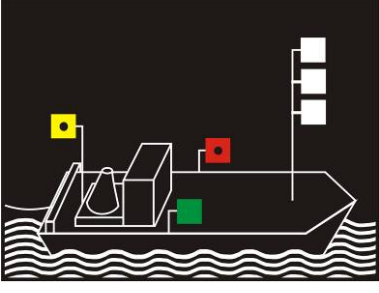
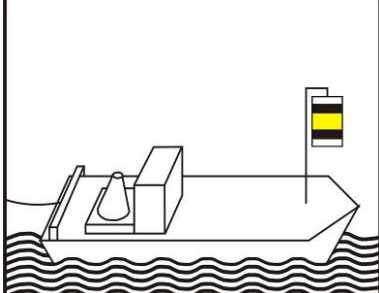
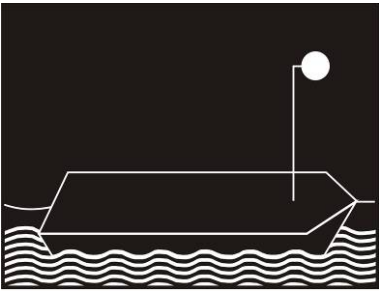
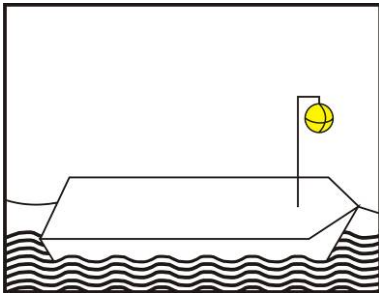
| Night | Sketch | Day |
|--|--------|--|
|  | 1 | |
| Article 3.08, paragraph 1: Motorized vessels proceeding alone. | | |
|  | 2 | |
| Article 3.08, paragraph 2: Motorized vessels proceeding alone with a second masthead light. Compulsory for vessels more than 110 m long. | | |
|  | 3 |  |
| Article 3.08, paragraph 3: Motorized vessel temporarily preceded by an auxiliary motorized vessel. | | |

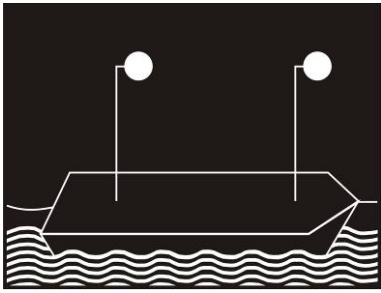
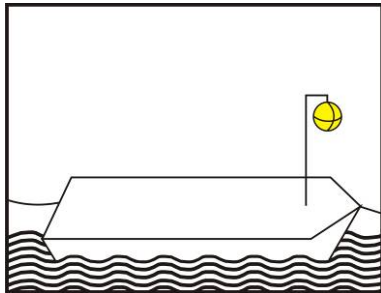
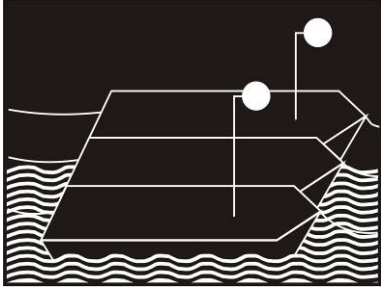
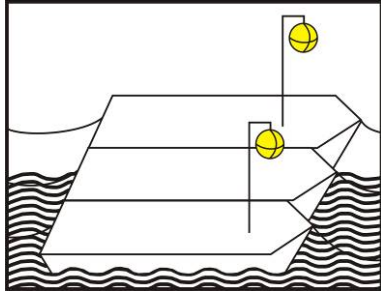
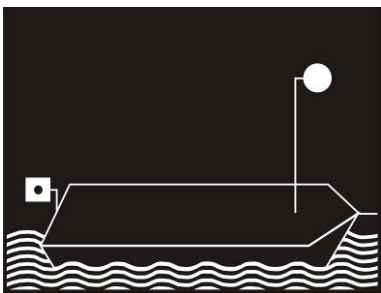
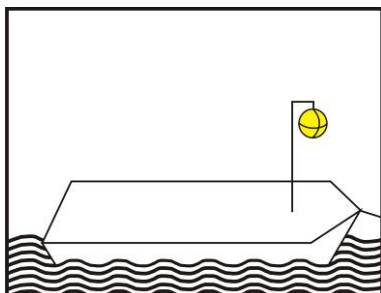
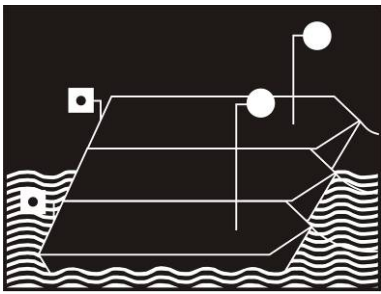
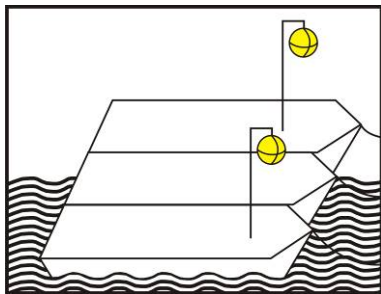
| Night | Sketch | Day |
|---|----------|--|
|  | <p>4</p> |  |
| <p>Article 3.08, paragraph 4: High-speed motorized vessel proceeding alone.</p> | | |
|  | <p>5</p> |  |
| <p>Article 3.09, paragraph 1: Motorized vessel leading a towed convoy or as an auxiliary.</p> | | |
|  | <p>6</p> |  |
| <p>Article 3.09, paragraph 2: Each of several motorized vessels leading a towed convoy or as auxiliaries, when several vessels are proceeding side by side.</p> | | |
|  | <p>7</p> |  |
| <p>Article 3.09, paragraph 3: Towed vessels.</p> | | |

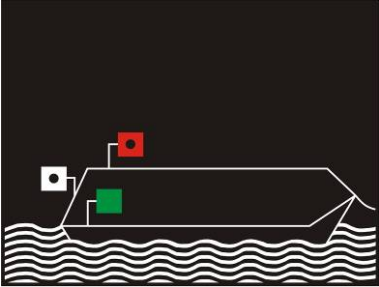
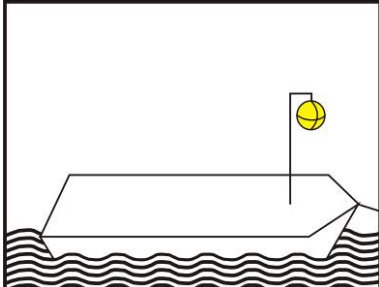
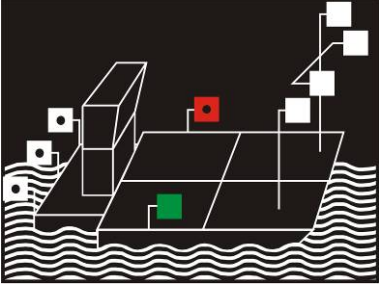
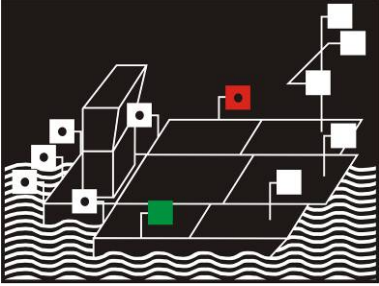
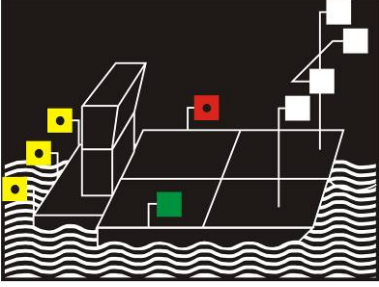
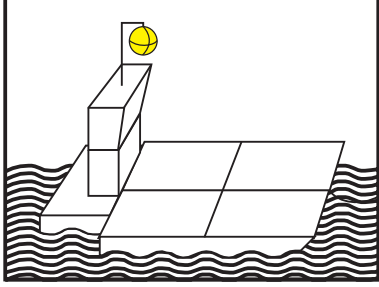

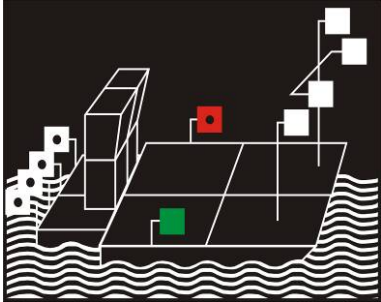
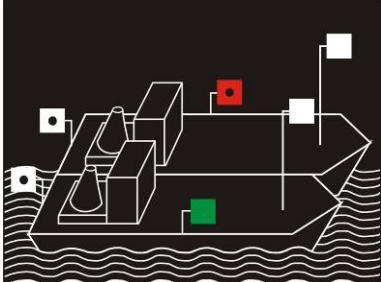
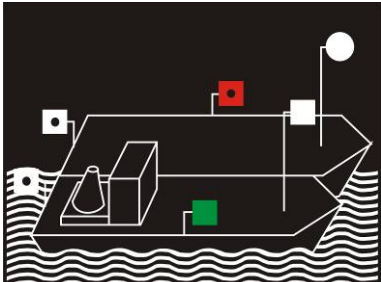
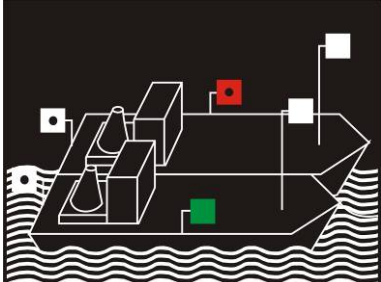
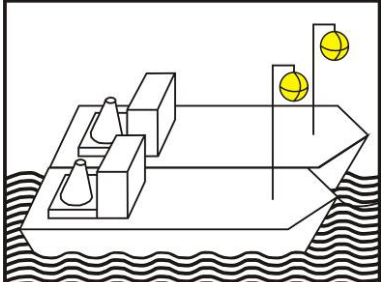
| Night | Sketch | Day |
|--|--------|--|
|  | 8 |  |
| Article 3.09, paragraph 3, letter a: Section of a towed convoy more than 110 m long. | | |
|  | 9 |  |
| Article 3.09, paragraph 3, letter b: Section of a towed convoy comprising a row of more than two vessels coupled side by side. | | |
|  | 10 |  |
| Article 3.09, paragraph 4: Last section of a towed convoy. | | |
|  | 11 |  |
| Article 3.09, paragraph 4: Towed vessels forming the last section of a convoy. | | |

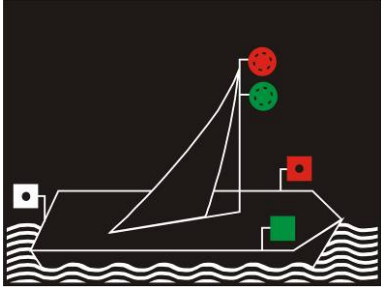
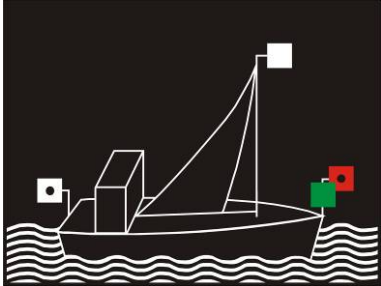
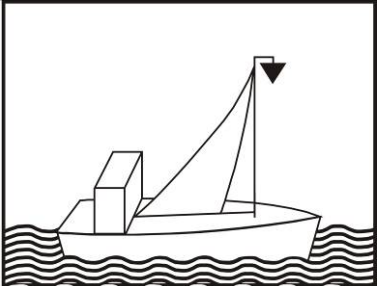
| Night | Sketch | Day |
|--|-----------|--|
|  | <p>12</p> |  |
| <p>Article 3.09, paragraph 5: Towed seagoing vessels coming directly from or leaving for the sea.</p> | | |
|  | <p>13</p> | |
| <p>Article 3.10, paragraph 1: Pushed convoys.</p> | | |
|  | <p>14</p> | |
| <p>Article 3.10, paragraph 1, letter c.ii: Pushed convoys, when more than two vessels other than the pusher are visible from astern over the full width.</p> | | |
|  | <p>15</p> |  |
| <p>Article 3.10, paragraph 2: Pushed convoys preceded by one or more auxiliary motorized vessels.</p> | | |

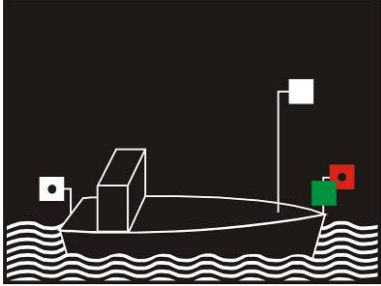
| Night | Sketch | Day |
|---|--------|--|
|  | 16 | |
| Article 3.10, paragraph 3: Pushed convoys with two pushers. | | |
|  | 17 | |
| Article 3.11, paragraph 1: Side-by-side formations: two motorized vessels. | | |
|  | 18 | |
| Article 3.11, paragraph 1: Side-by-side formations: one motorized and one non-motorized vessel. | | |
|  | 19 |  |
| Article 3.11, paragraph 2: Side-by-side formations preceded by one or more auxiliary motorized vessels. | | |

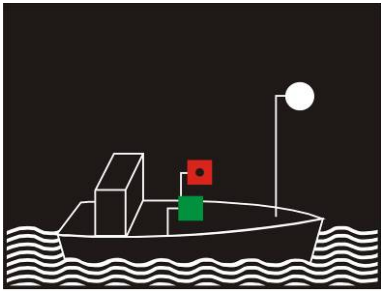
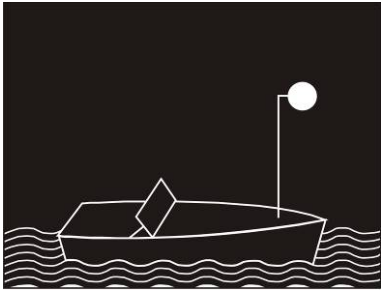
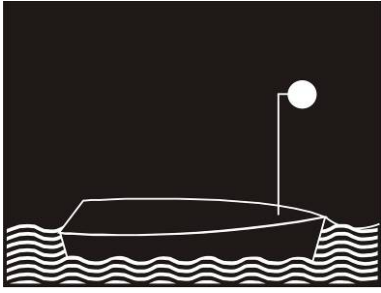
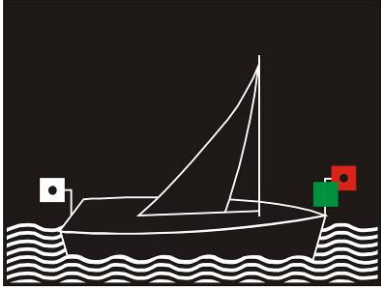
| Night | Sketch | Day |
|---|--------|---|
|  | 20 | |
| Article 3.12: Sailing vessels. | | |
|  | 21 |  |
| Article 3.12, paragraph 3: Vessels proceeding under sail and making use at the same time of its own mechanical means of propulsion. | | |
|  | 22 | |
| Article 3.13, paragraph 1: Motorized small craft proceeding alone. | | |
|  | 23 | |
| Article 3.13, paragraph 1: Motorized small craft proceeding alone with side lights side by side or in the same lamp at or near the bow. | | |

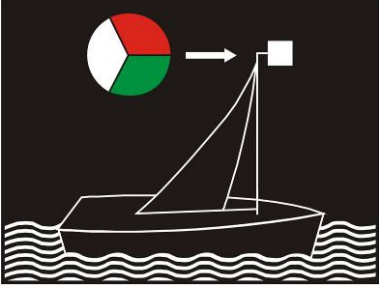
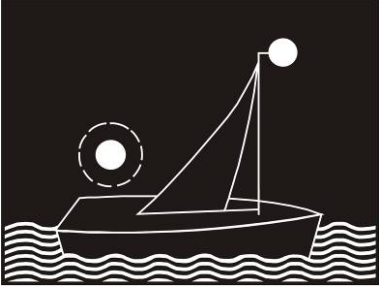
| Night | Sketch | Day |
|--|--------|-----|
|  | 24 | |
| <p>Article 3.13, paragraph 1: Motorized small craft proceeding alone: the masthead light replaced by a bright white light visible from all directions.</p> | | |
|  | 25 | |
| <p>Article 3.13, paragraph 2: Motorized small craft less than 7 m long proceeding alone.</p> | | |
|  | 26 | |
| <p>Article 3.13, paragraph 4: Small craft towed or propelled in side-by-side formation.</p> | | |
|  | 27 | |
| <p>Article 3.13, paragraph 5: Small sailing craft.</p> | | |

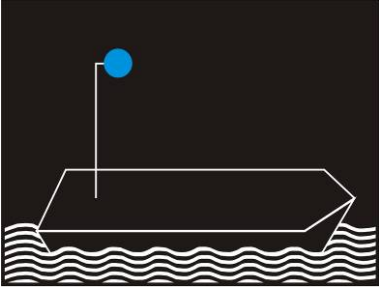
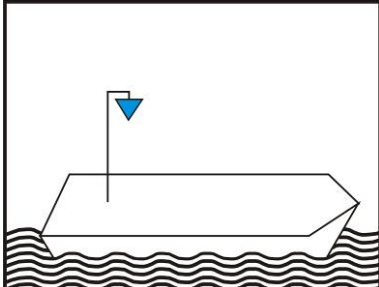
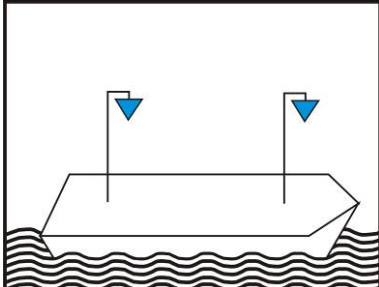
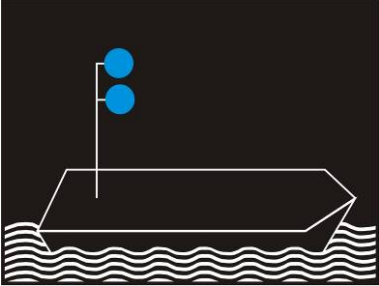
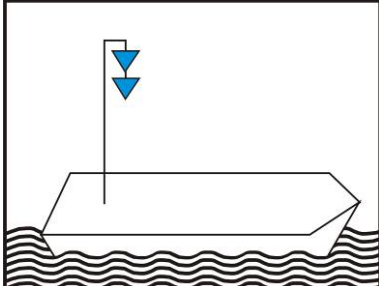
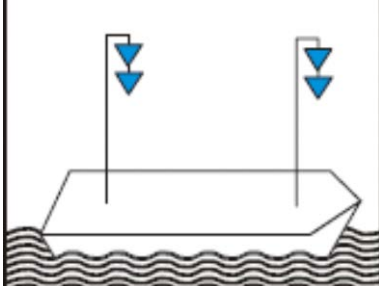

| Night | Sketch | Day |
|---|-----------|-----|
|  | <p>28</p> | |
| <p>Article 3.13, paragraph 5: Small sailing craft, with side lights and a stern light in the same lamp near the top of the mast.</p> | | |
|  | <p>29</p> | |
| <p>Article 3.13, paragraph 5: Sailing small craft less than 7 m long carrying a white light visible from all directions, and on the approach of other vessels displaying a second ordinary white light.</p> | | |
|  | <p>30</p> | |
| <p>Article 3.13, paragraph 6: Small craft proceeding alone, neither motorized nor under sail.</p> | | |

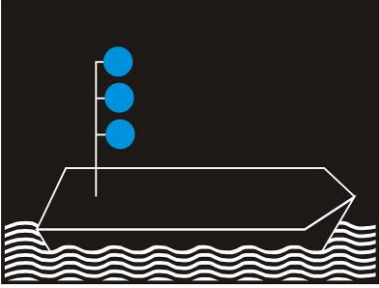
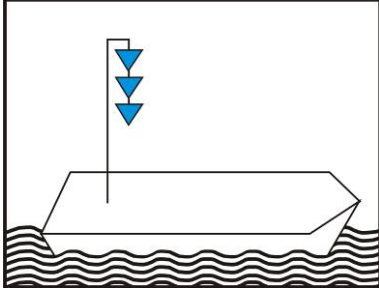
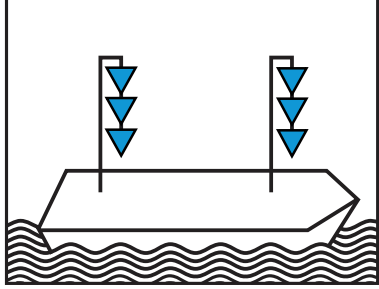
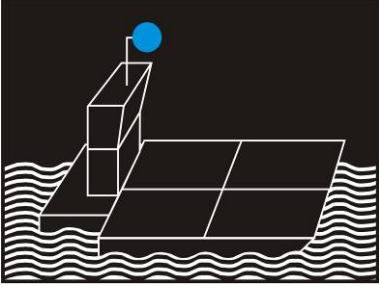
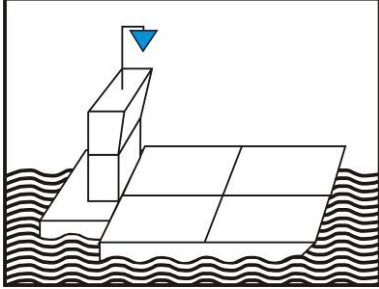
| Night | Sketch | Day |
|--|------------|--|
|  | <p>31a</p> |  |
| | <p>31b</p> |  |
| <p>Article 3.14, paragraph 1: Additional marking for vessels carrying out certain transport operations involving dangerous substances: flammable substances that are referred to in accordance with the requirements of sub-section 7.1.5.0 or sub-section 7.2.5.0 of ADN and Chapter 3.2, Table A, column (12) or Table C column (19) of ADN.</p> | | |
|  | <p>32a</p> |  |
| | <p>32b</p> |  |
| <p>Article 3.14, paragraph 2: Additional marking for vessels carrying out certain transport operations involving dangerous substances: substances constituting health hazards in accordance with the requirements of sub-section 7.1.5.0 or sub-section 7.2.5.0 of ADN and Chapter 3.2, Table A, column (12) or Table C column (19) of ADN.</p> | | |

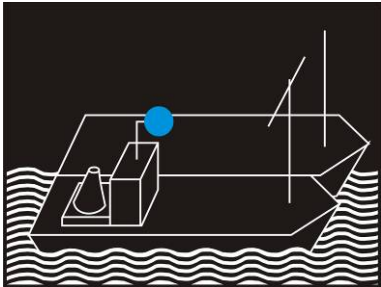
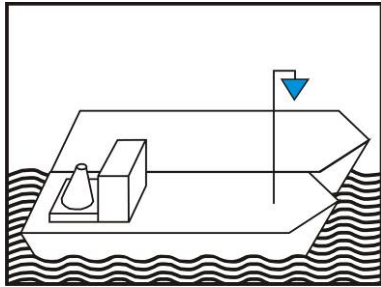
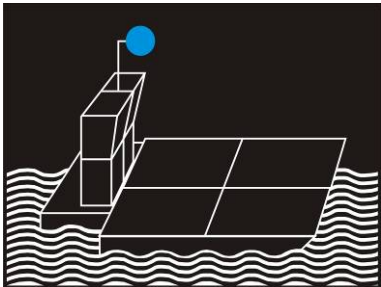
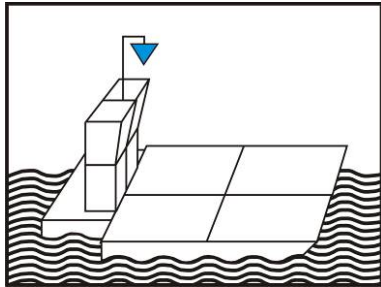
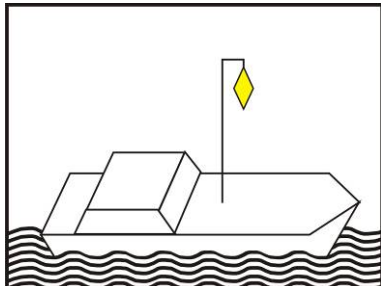
| Night | Sketch | Day |
|---|------------|--|
|  | <p>33a</p> |  |
| | <p>33b</p> |  |
| <p>Article 3.14, paragraph 3: Additional marking of vessels carrying out certain transport operations involving dangerous substances: explosives in accordance with the requirements of sub-section 7.1.5.0 or sub-section 7.2.5.0 of ADN and Chapter 3.2, Table A, column (12) of ADN.</p> | | |
|  | <p>34</p> |  |
| <p>Article 3.14, paragraph 4: Additional marking of pushed convoys carrying out certain transport operations involving dangerous substances in accordance with the requirements of sub-section 7.1.5.0 or sub-section 7.2.5.0 of ADN and Chapter 3.2, Table A, column (12) or table C column (19) of ADN.</p> | | |

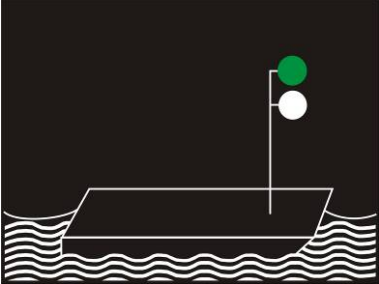
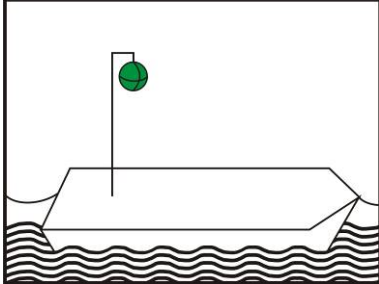
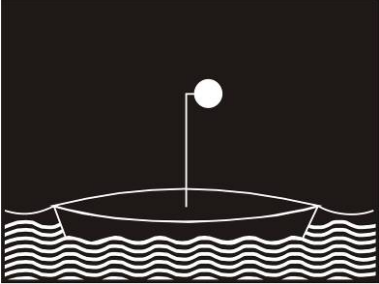
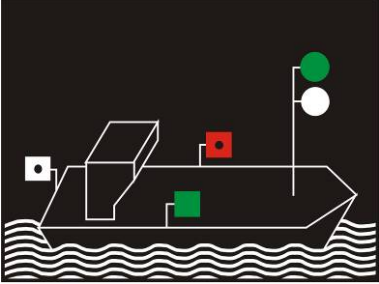
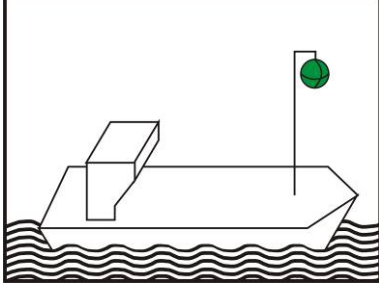
| Night | Sketch | Day |
|--|-----------|--|
|  | <p>35</p> |  |
| <p>Article 3.14, paragraph 4: Additional marking of side-by-side formations carrying out certain transport operations involving dangerous substances in accordance with the requirements of sub-section 7.1.5.0 or sub-section 7.2.5.0 of ADN and Chapter 3.2, Table A, column (12) or Table C column (19) of ADN.</p> | | |
|  | <p>36</p> |  |
| <p>Article 3.14, paragraph 5: Additional marking of pushed convoys propelled by two pushers placed side by side and carrying out certain transport operations involving dangerous substances in accordance with the requirements of sub-section 7.1.5.0 or sub-section 7.2.5.0 of ADN and Chapter 3.2, Table A, column (12) or Table C column (19) of ADN.</p> | | |
| | <p>37</p> |  |
| <p>Article 3.15: Vessels authorized to carry more than 12 passengers with a hull length of less than 20 m.</p> | | |

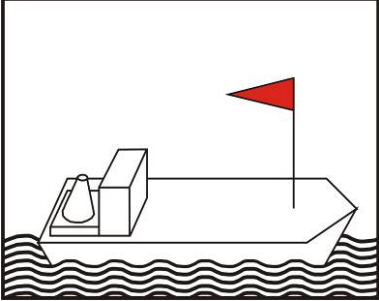
| Night | Sketch | Day |
|---|-----------|--|
|  | <p>38</p> |  |
| <p>Article 3.16, paragraph 1: Ferry-boats not moving independently.</p> | | |
|  | <p>39</p> | |
| <p>Article 3.16, paragraph 2: Leading boat or float of a longitudinal-cable ferry-boat.</p> | | |
|  | <p>40</p> |  |
| <p>Article 3.16, paragraph 3: Ferry-boats moving independently.</p> | | |
| <p>Left void</p> | <p>41</p> | <p>Left void</p> |
| <p>Article 3.16, paragraph 4: Ferry-boats moving independently and enjoying priority.</p> | | |

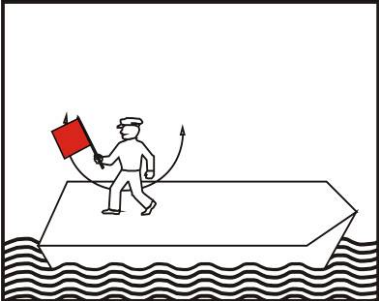
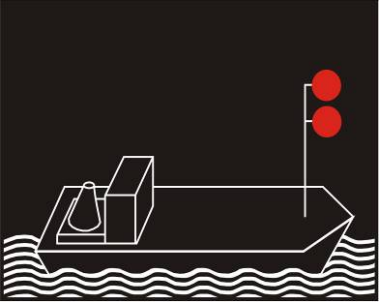
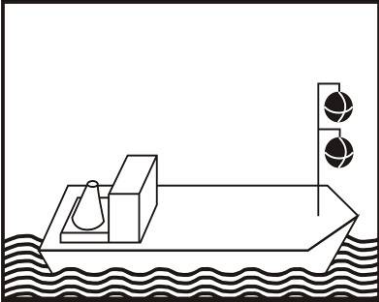
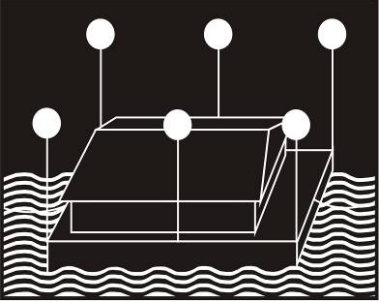
| Night | Sketch | Day |
|--|--------|--|
| | 42 |  |
| Article 3.17: Vessels having priority of passage. | | |
|  | 43a |  |
|  | 43b |  |
| Article 3.18, paragraph 1: Additional marking for vessels unable to manoeuvre. | | |
|  | 44 | |
| Article 3.19: Assemblies of floating material and floating establishments under way. | | |

III. MARKING WHEN STATIONARY

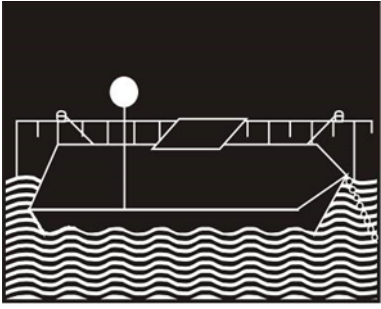
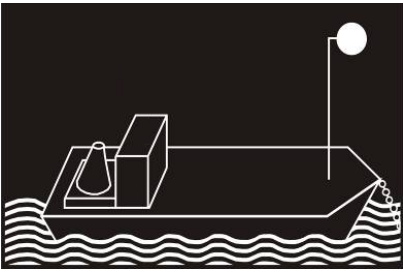
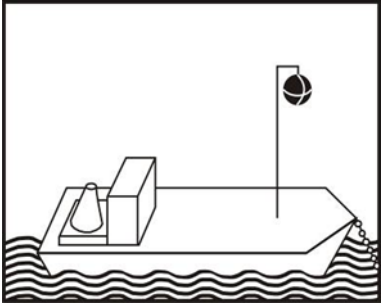
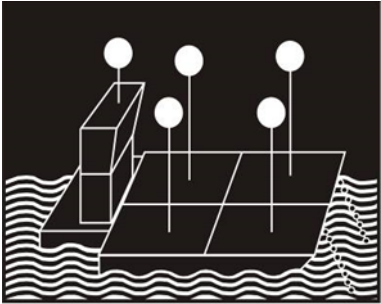
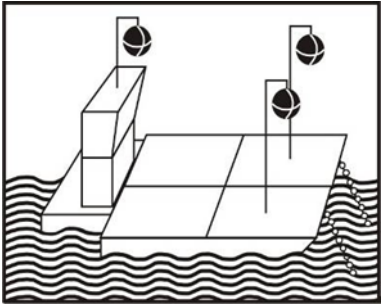
| Night | Sketch | Day |
|---|--------|--|
|  | 45 | |
| Article 3.20, paragraph 1: All stationary vessels. | | |
|  | 46 |  |
| Article 3.20, paragraph 1: Vessels stationary offshore. | | |
|  | 47 |  |
| Article 3.20, paragraph 2: Pushed convoys stationary offshore. | | |

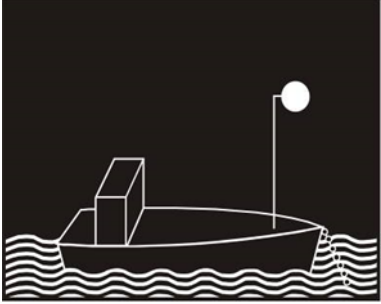
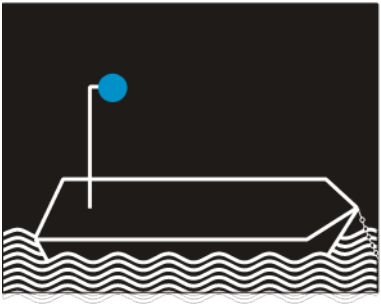
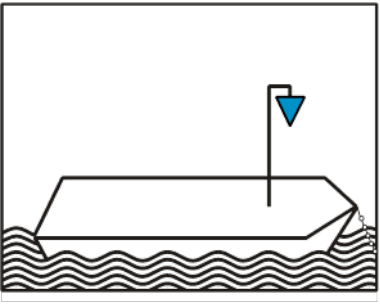
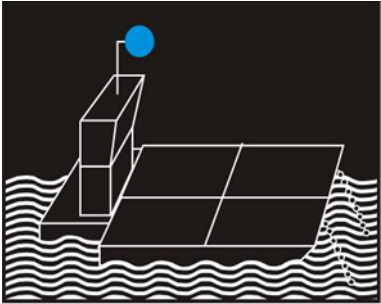
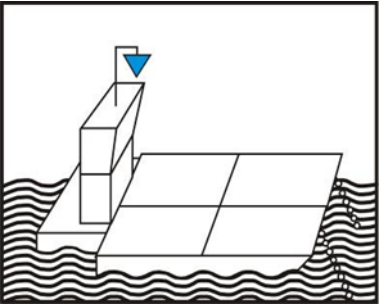
| Night | Sketch | Day |
|---|-----------|--|
|  | <p>48</p> | |
| <p>Article 3.20, paragraph 3: Small craft stationary offshore.</p> | | |
|  | <p>49</p> |  |
| <p>Article 3.21: Additional marking for stationary vessels carrying out certain transport operations involving dangerous substances.</p> | | |
|  | <p>50</p> |  |
| <p>Article 3.21: Additional marking for stationary pushed convoys carrying out certain transport operations involving dangerous substances.</p> | | |

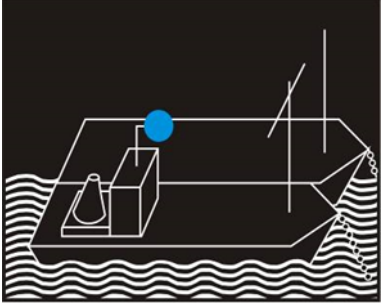
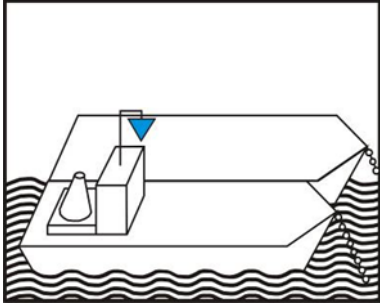
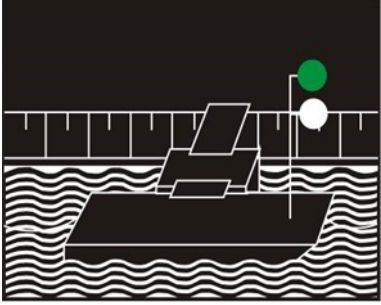
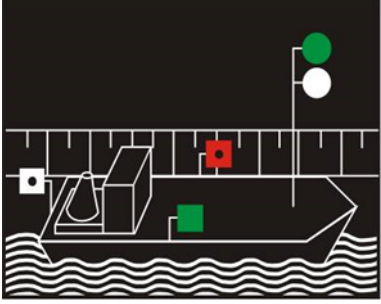
| Night | Sketch | Day |
|--|--------|--|
|  | 51 |  |
| <p>Article 3.21: Additional marking for stationary side-by-side formations carrying out certain transport operations involving dangerous substances.</p> | | |
|  | 52 | |
| <p>Article 3.22, paragraph 1: Ferry-boats not moving independently when made fast at their landing stage.</p> | | |
|  | 53 | |
| <p>Article 3.22, paragraph 2: Ferry-boats moving independently, but made fast at their landing stage.</p> | | |

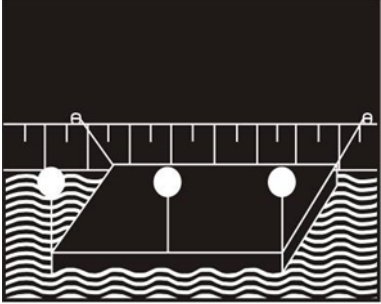
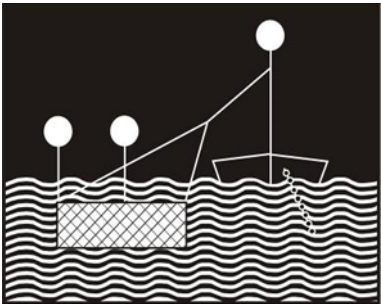
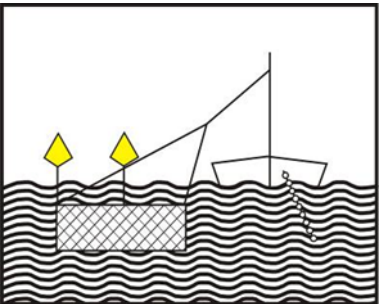
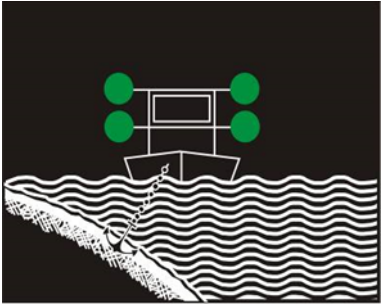
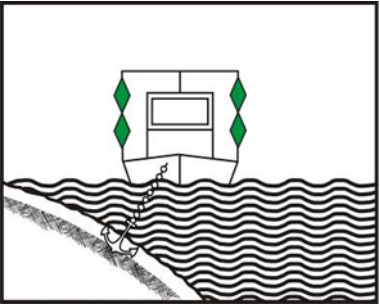

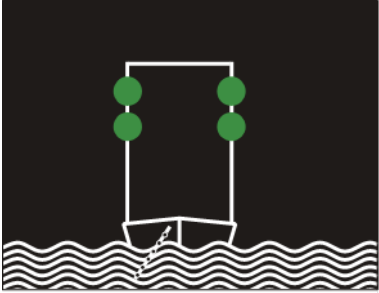
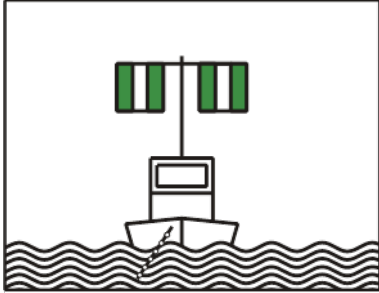
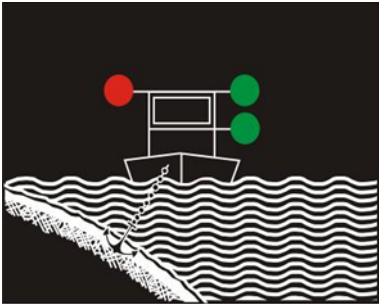
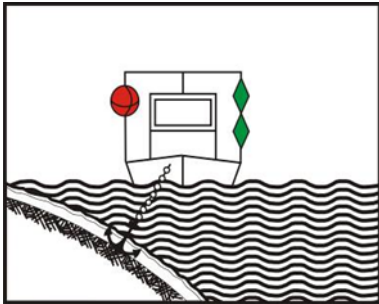
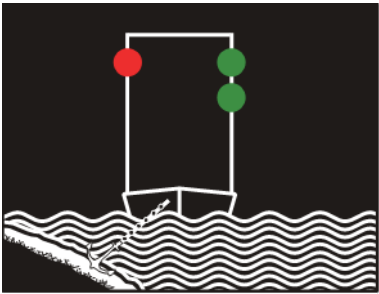
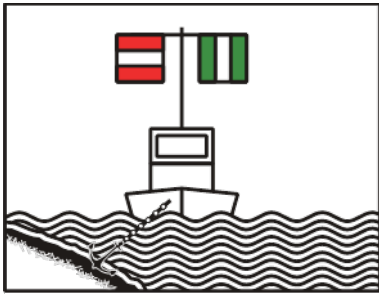
| Night | Sketch | Day |
|--|--------|--|
|  | 54 | |
| Article 3.23: Assemblies of floating material and floating establishments when stationary. | | |
|  | 55 |  |
| Article 3.24: Stationary vessels engaged in fishing with nets or poles. | | |
|  | 56 |  |
| Article 3.25, paragraph 1, letter a: Floating equipment at work and stationary vessels carrying out work or sounding or measuring operations; fairway clear on both sides. | | |

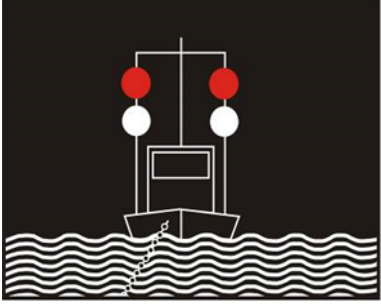
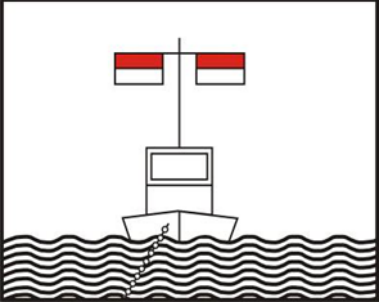
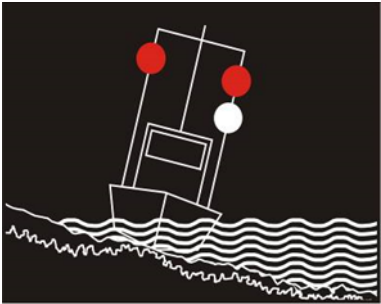
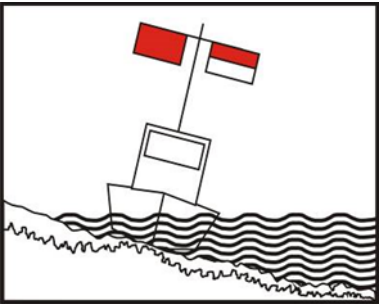
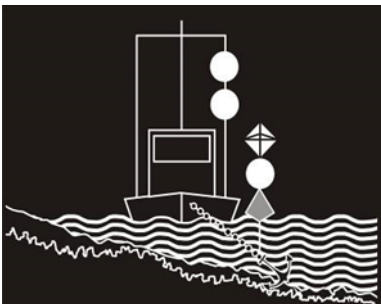
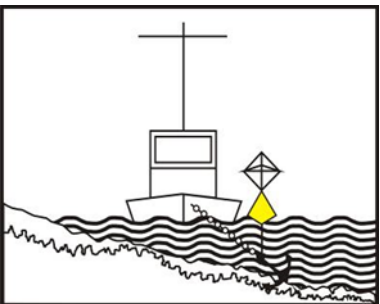

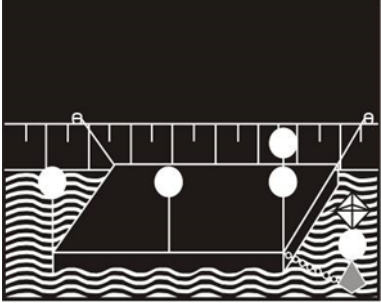
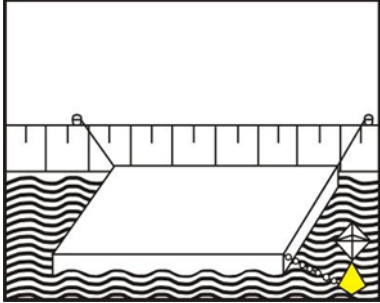

| Night | Sketch | Day |
|--|---------------|--|
|  | <p>56 bis</p> |  |
| <p>Article 3.25, paragraph 4: Grounded or sunken vessels; fairway clear on both sides.</p> | | |
|  | <p>57</p> |  |
| <p>Article 3.25, paragraph 1, letters a and b: Floating equipment at work and stationary vessels carrying out work or sounding or measuring operations; fairway clear on one side.</p> | | |
|  | <p>57 bis</p> |  |
| <p>Article 3.25, paragraph 4: Grounded or sunken vessels; fairway clear on one side.</p> | | |

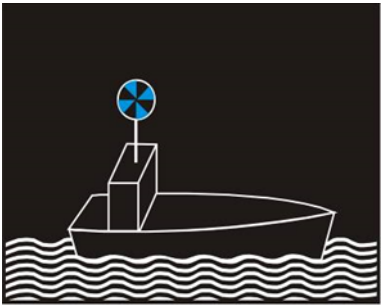
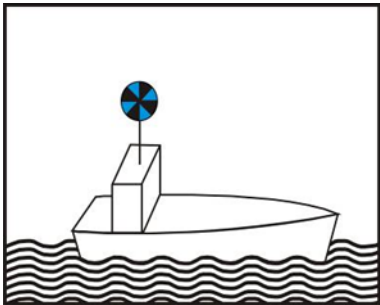
| Night | Sketch | Day |
|---|-----------|--|
|  | <p>58</p> |  |
| <p>Article 3.25, paragraph 1, letter c, and paragraph 4: Floating equipment at work and vessels carrying out work or sounding or measuring operations and grounded or sunken vessels; protection against wash; fairway clear on both sides.</p> | | |
|  | <p>59</p> |  |
| <p>Article 3.25, paragraph 1, letters c and d and paragraph 4: Floating equipment at work and vessels carrying out work or sounding or measuring operations and grounded or sunken vessels; protection against wash; fairway clear on one side.</p> | | |
|  | <p>60</p> |  |
| <p>Article 3.26: Vessels whose anchors may be a danger to navigation.</p> | | |

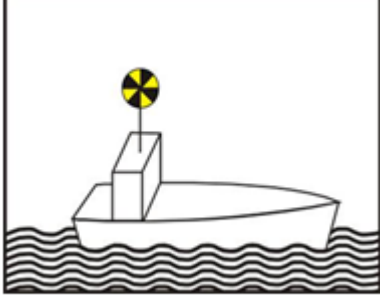

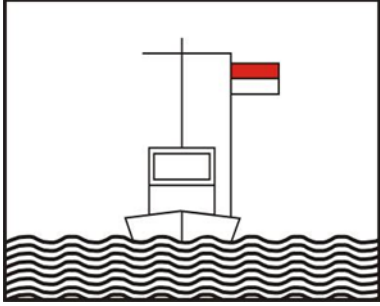
| Night | Sketch | Day |
|--|-----------|--|
|  | <p>61</p> |  |
| <p>Article 3.26: Assemblies of floating material or floating establishments whose anchors may be a danger to navigation.</p> | | |

IV. SPECIAL MARKING

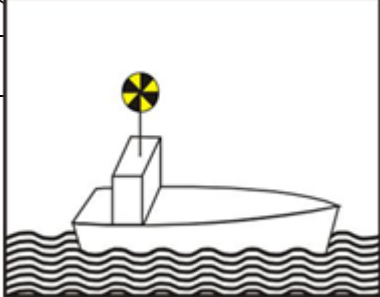
| Night | Sketch | Day |
|---|-----------|--|
|  | <p>62</p> |  |
| <p>Article 3.27: Additional marking for vessels of the supervisory authorities and fire-fighting and rescue services.</p> | | |
|  | <p>63</p> |  |
| <p>Article 3.28: Additional marking for vessels under way carrying out work in the waterway.</p> | | |

| Night | Sketch | Day |
|--|-----------|--|
|  | <p>64</p> |  |
| <p>Article 3.29: Additional marking for protection against wash.</p> | | |
|  | <p>65</p> |  |
| <p>Article 3.30: Distress signals.</p> | | |
|  | <p>66</p> |  |
| <p>Article 3.31: No access for unauthorized persons.¹</p> | | |
|  | | |

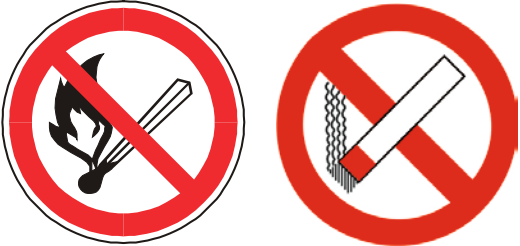
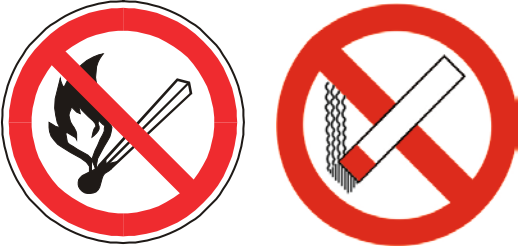
¹ The first sketch illustrates the new sign for “Boarding prohibited”. The second sketch illustrates the existing sign. For a transitional period both signs may be used.

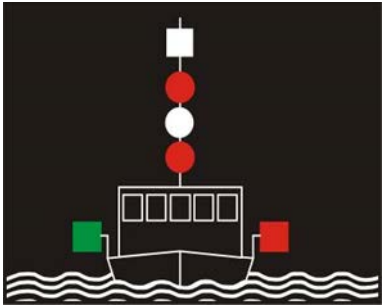
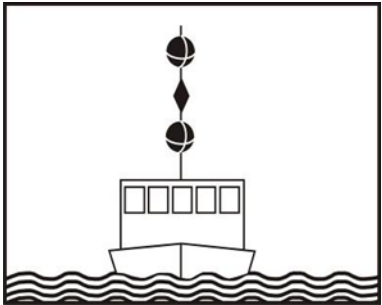
| Night | Sketch | Day |
|---|-----------|--|
|  | <p>67</p> |  |
| <p>Article 3.32: Prohibition of smoking or using fires and naked light.²</p> | | |
|  | <p>68</p> |  |
| <p>Article 3.33: Lateral berthing prohibited.</p> | | |
|  | <p>69</p> |  |
| <p>Article 3.34, paragraph 1: Additional marking for vessels whose ability to manoeuvre is limited.</p> | | |

² The first sketch illustrates the new sign for “Prohibition of smoking or using fires and naked light”. The second sketch illustrates the existing sign. For a transitional period both signs may be used.

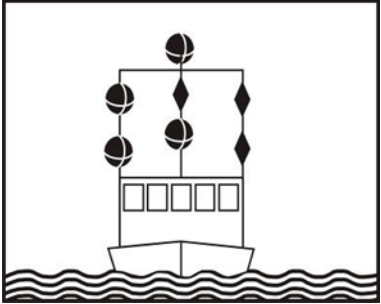
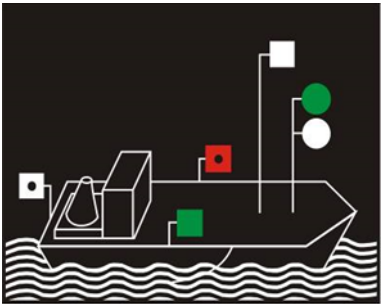
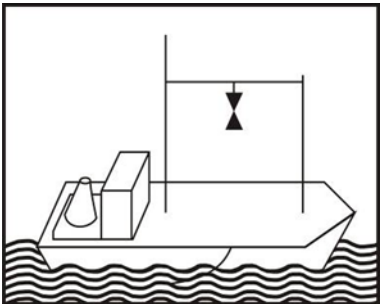
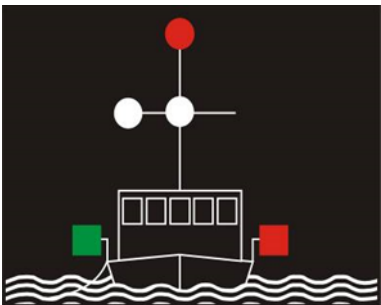
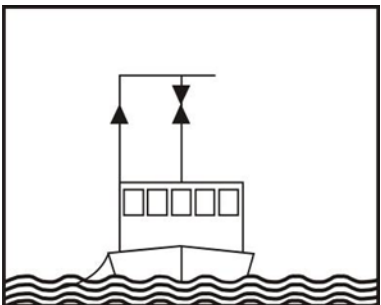
| Night | Sketch | Day |
|---|---------------------------------------|--|
|  | <p style="text-align: center;">70</p> |  |
| <p>Article 3.34, paragraph 2: Additional marking for vessels whose ability to manoeuvre is limited; fairway clear on one side.</p> | | |
|  | <p style="text-align: center;">71</p> |  |
| <p>Article 3.35, paragraph 1: Additional marking for vessels engaged in drawing a trawl or other fishing gear through the water (trawler).</p> | | |
|  | <p style="text-align: center;">72</p> |  |
| <p>Article 3.35, paragraph 2: Fishing vessels other than trawlers if the fishing tackle extends more than 150 m horizontally from the vessel.</p> | | |

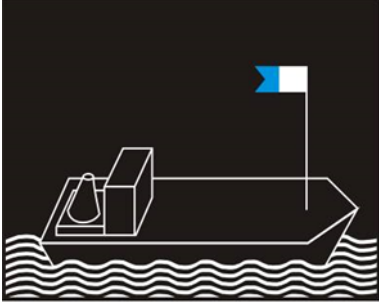
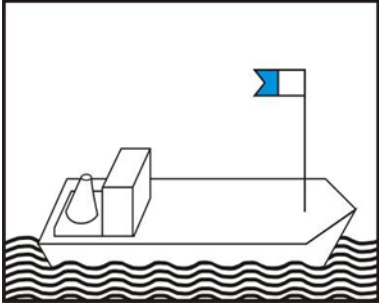
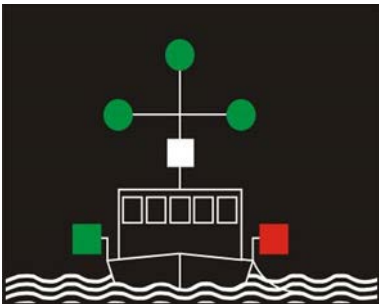
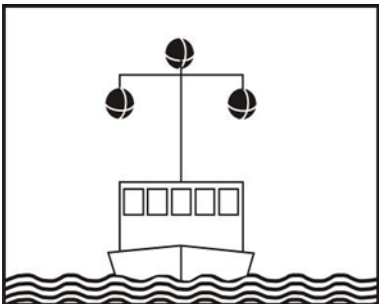
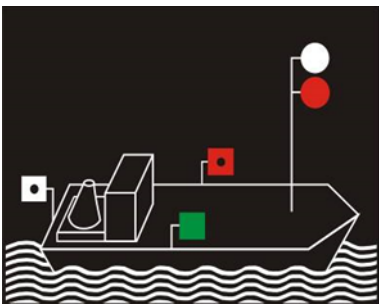
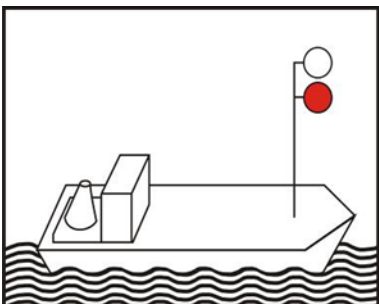
| Night | Sketch | Day |
|---|--------|--|
|  | 73 |  |
| Article 3.36: Additional marking for vessels used for underwater diving. | | |
|  | 74 |  |
| Article 3.37: Additional marking for vessels engaged in minesweeping. | | |
|  | 75 |  |
| Article 3.38: Additional marking for vessels on pilotage service. | | |

Annex 4 LIGHTS AND THE COLOUR OF SIGNAL LIGHTS ON VESSELS

(Left void)³

³ Requirements to lights and the colour of signal lights on vessels shall be included in “Recommendations on Harmonized Europe-Wide Technical Requirements for Inland Navigation Vessels” (Resolution No. 61).

Annex 5 INTENSITY AND RANGE OF SIGNAL LIGHTS ON VESSELS

(Left void)⁴

⁴ Requirements to intensity and range of signal lights on vessels shall be included in “Recommendations on Harmonized Europe-Wide Technical Requirements for Inland Navigation Vessels” (Resolution No. 61).

Annex 6 SOUND SIGNALS

I. SOUND INTENSITY OF SIGNALS

Requirements to sound intensity of signals are included in “Recommendations on Harmonized Europe-Wide Technical Requirements for Inland Navigation Vessels” (Resolution No. 61, amended).

II. MONITORING OF SOUND PRESSURE LEVEL

Requirements to monitoring of sound pressure level shall be included in “Recommendations on Harmonized Europe-Wide Technical Requirements for Inland Navigation Vessels” (Resolution No. 61, amended).









III. SOUND SIGNALS TO BE USED BY VESSELS

Sound signals other than the ringing of a bell and the three-tone signal shall consist in the emission of one blast or of several successive blasts having the following characteristics:

- (a) Short blast: a blast lasting about one second;
- (b) Long blast: a blast lasting about four seconds.

The interval between two successive blasts shall be about one second except for the signal “series of very short blasts” which shall comprise a series of not less than six blasts, each lasting about a quarter of a second, separated by a silence of the same duration.

A. General signals

| | | | |
|--|-------------------------------------|--|--------------|
|  | 1 long blast | "Caution" | |
|  | 1 short blast | "I am altering my course to starboard" | |
|  | 2 short blasts | "I am altering my course to port" | |
|  | 3 short blasts | "I am going astern" | |
|  | 4 short blasts | "I am unable to manoeuvre" | |
|  | Repeated, 1 short and 1 long blasts | "Do not approach" | |
|  | Series of very short blasts | "Imminent danger of collision" | |
|  | Repeated long blasts | "Distress signs" | Article 4.04 |
|  | Ringing of a bell | | |

B. Meeting signals

Request to pass on the port side





| | | | |
|-----|--|---|---------------------------|
| ■ | 1 short blast by vessel proceeding upstream | "I wish to pass on the port side" | Article 6.04, paragraph 5 |
| ■ | 1 short blast by vessel proceeding downstream | "Agreed; pass on the port side" | Article 6.04, paragraph 6 |
| ■ ■ | 2 short blasts by vessel proceeding downstream | "No; pass on the starboard side" | Article 6.05, paragraph 3 |
| ■ ■ | 2 short blasts by vessel proceeding upstream | "Agreed; I will pass on the starboard side" | Article 6.05, paragraph 4 |

Request to pass on the starboard side





| | | | |
|-----|--|--|---------------------------|
| ■ ■ | 2 short blasts by vessel proceeding upstream | "I wish to pass on the starboard side" | Article 6.04, paragraph 5 |
| ■ ■ | 2 short blasts by vessel proceeding downstream | "Agreed; pass on the starboard side" | Article 6.04, paragraph 6 |
| ■ | 1 short blast by vessel proceeding downstream | "No; pass on the port side" | Article 6.05, paragraph 3 |
| ■ | 1 short blast by vessel proceeding upstream | "Agreed; I will pass on the port side" | Article 6.05, paragraph 4 |

C. Overtaking signals

Request to overtake on the port side

| | | | |
|---|---|---|------------------------------|
|  | 2 long blasts followed by 2 short blasts, by overtaking vessel | "I wish to overtake on your port side" | Article 6.10, paragraph 2 |
|  | 1 short blast by vessel to be overtaken | "Agreed; overtake on my port side" | Article 6.10, paragraph 3 |
|  | 2 short blasts by vessel to be overtaken | "No; overtake on my starboard side" | Article 6.10, paragraph 4 |
|  | 1 short blast by overtaking vessel | "Agreed; I will pass on your starboard side" | Article 6.10, paragraph 4 |



Request to overtake on the starboard side

| | | | |
|---|---|--|------------------------------|
|  | 2 long blasts followed by 1 short blast by overtaking vessel | "I wish to pass on your starboard side" | Article 6.10, paragraph 2 |
|  | 2 short blasts by vessel to be overtaken | "Agreed; overtake on my starboard side" | Article 6.10, paragraph 3 |
|  | 1 short blast by vessel to be overtaken | "No; overtaken on my port side" | Article 6.10, paragraph 4 |
|  | 2 short blasts by overtaking vessel | "Agreed; I will overtake on your port side" | Article 6.10, paragraph 4 |

Overtaking impossible



| | | | |
|---|---|-------------------------|------------------------------|
|  | 5 short blasts by vessel to be overtaken | "I cannot be overtaken" | Article 6.10, paragraph 5 |
|---|---|-------------------------|------------------------------|

D. Turning signals



| | | | |
|---|--|--------------------------------------|------------------------------|
|  | 1 long blast followed by 1 short blast | "I am going to turn to starboard" | Article 6.13, paragraph 2 |
|  | 1 long blast followed by 2 short blasts | "I am going to turn to port" | Article 6.13, paragraph 2 |

E. Harbours and tributary waterways: entering and leaving, followed by crossing the waterway

E.1 Signals on entering and leaving harbours and tributary waterways

| | | | |
|---|---|---------------------------|------------------------------|
|  | 3 long blasts followed by 1 short blast | "I am going to starboard" | Article 6.16, paragraph 2 |
|  | 3 long blasts followed by 2 short blasts | "I am going to port" | Article 6.16, paragraph 2 |

E.2 Signals on crossing after entering the waterway

| | | | |
|---|--|---------------------------|------------------------------|
|  | 3 long blasts | "I am going to cross" | Article 6.16, paragraph 2 |
| followed if necessary by: | | | |
|  | 1 long blast followed by 1 short blast | "I am going to starboard" | Article 6.16, paragraph 2 |
|  | 1 long blast followed by 2 short blasts | "I am going to port" | Article 6.16, paragraph 2 |

F. *Signals in reduced visibility*

(a) Vessels navigating by radar



(i) Vessels, other than small craft, proceeding downstream

Three-tone signal repeated as often as necessary

Article 6.32, paragraph 4 (a)



(ii) Single vessel proceeding upstream

1 long blast

Article 6.32, paragraph 4 (c)

(b) Vessels not navigating by radar



(i) Any vessel proceeding alone

1 long blast repeated at least once a minute

Article 6.33, paragraph 1 (b)



(ii) Ferry boats not navigating by radar

One long blast followed by four short blasts; repeated at intervals of not more than one minute

Article 6.33, paragraph 2

Annex 7 WATERWAY SIGNS AND MARKING

(1) The main signs given in section I below may be supplemented or clarified by auxiliary signs given in section II.

(2) To make them more visible, boards may be surrounded by a thin white line.

I. MAIN SIGNS

A. PROHIBITORY SIGNS

A.1 No entry (general sign) A.1a boards

(see articles 3.25, paragraph 2 (b), 6.08, 6.16, 6.22, 6.22 bis, 6.25, 6.26, 6.27 and 6.28 bis)



A.1b, A.1c and
A.1d

or red lights



Two boards, two lights
or two flags, one above
the other, indicate a
prolonged prohibition

A.1e and A.1f
or red flags

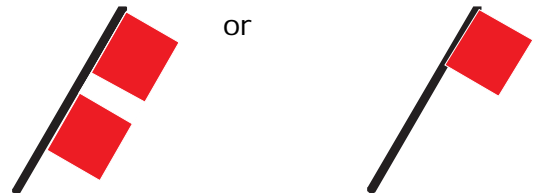

A.1.1 Sections closed to use, A.1g
no entry except for
non-motorized small
craft (see article 6.22)



A.2 No overtaking
(see article 6.11, a))

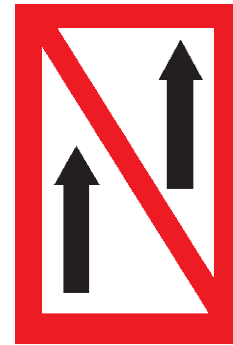

A.3 No overtaking of convoys by convoys
(see article 6.11, b))

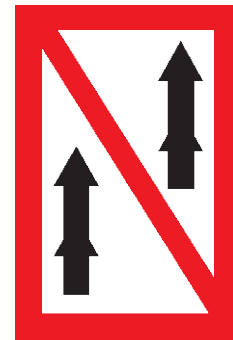

A.4 No passing or overtaking
(see article 6.08, para. 1)

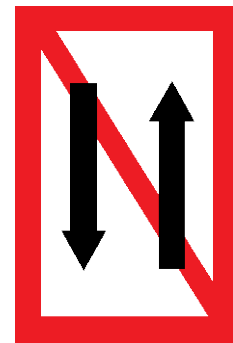

A.4.1 No passing or overtaking of convoys by convoys

(See article 6.08, para. 1)

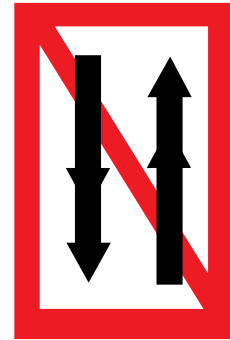

A.5 No berthing on the side of the waterway on which the sign is placed (i.e. no anchoring or making fast to the bank)

(see article 7.02, para. 1)



A.5.1 No berthing on the stretch of water whose breadth, measured from the sign, is shown in metres on the sign

(see article 7.02, para. 1)



A.6 No anchoring or trailing of anchors, cables or chains on the side of the waterway on which the sign is placed

(see articles 6.18, para. 2 and 7.03, para. 1(b))

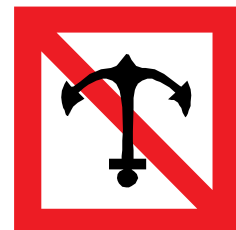

A.7 No making fast to the bank on the side of the waterway on which the sign is placed

(see article 7.04, para. 1(b))



A.8 No turning

(see article 6.13, para. 5)

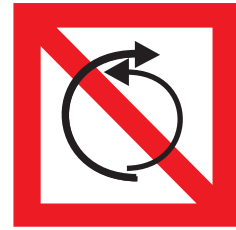

A.9 Do not create wash likely to cause damage

(see article 6.20, para. 1 (e))

A.9a



or

A.9b



A.10 No passing outside the area marked
(in openings of bridges or weirs)

(see article 6.24, para. 2 (a))



A.11 Entry prohibited, but prepare to get under way
(see articles 6.26 and 6.28 bis)

A.11a



or

A.11b



or

A.11c

(red light extinguished)



A.12 Motorized craft prohibited

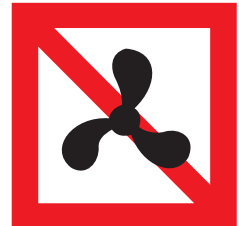

A.13 Sports or pleasure craft prohibited



A.14 Water skiing prohibited



A.15 Sailing vessels prohibited

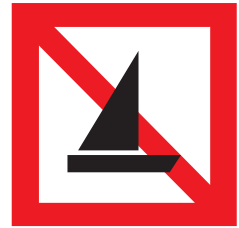

A.16 All craft other than motorized vessels or sailing craft prohibited



A.17 Use of sailboards prohibited



A.18 End of zone authorized for high speed navigation of small sport and pleasure craft



A.19 No launching or beaching of vessels



A.20 Water bikes prohibited



B. MANDATORY SIGNS

B.1 Proceed in the direction shown by the arrow
(see article 6.12, para. 1)

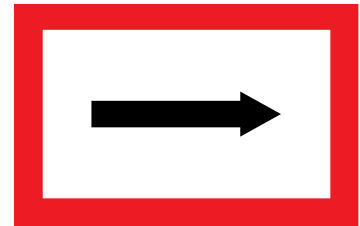

B.2

B.2a Move to the side of the fairway on your
port side
(see article 6.12, para. 1)

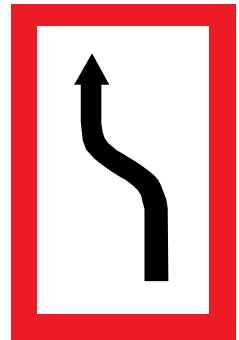

B.2b Move to the side of the fairway on your
starboard side
(see article 6.12, para. 1)

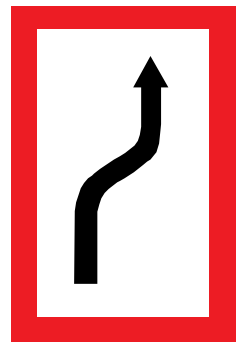

B.3

B.3a Keep to the side of the fairway on your port side

(see article 6.12, para. 1)

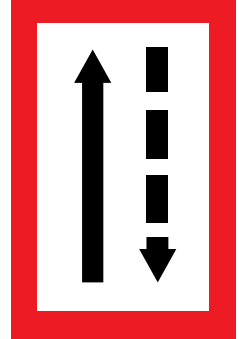

B.3b Keep to the side of the fairway on your starboard side

(see article 6.12, para. 1)

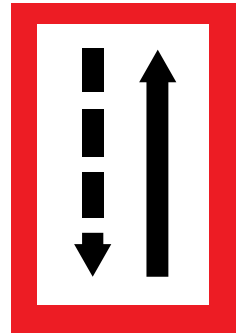

B.4

B.4a Cross fairway to port

(see article 6.12, para. 1)

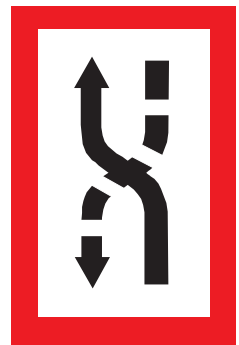

B.4b Cross fairway to starboard

(see article 6.12, para. 1)



B.5 Stop as prescribed in the Regulations
(see articles 6.26, para. 2 and 6.28, para. 1)



B.6 Do not exceed the speed indicated (in km/h)



B.7 Give a sound signal

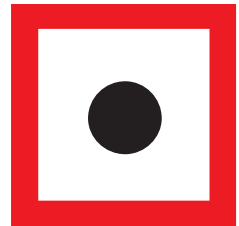

B.8 Keep a particularly sharp lookout
(see article 6.08, para. 2)



B.9 Do not enter or cross the main waterway until certain that this will not oblige vessels proceeding on it to change their course or speed

(see article 6.16, para. 4)

B.9a



B.9b



B.10 Vessels proceeding on the main waterway must, if necessary, change course and speed to allow vessels to leave harbours or tributary waterways

(see article 6.16, paras 3 and 6)



B.11

B.11a Obligation to enter into a radiotelephone link
(see article 4.05, para. 5)



B.11b Obligation to enter into a radiotelephone link on the channel as indicated on the board
(see article 4.05, para. 5)



C. RESTRICTIVE SIGNS

C.1 Depth of water limited

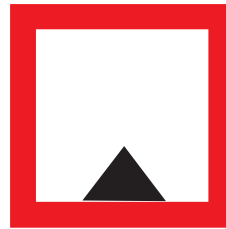

C.1a

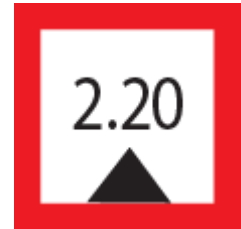

C.1b

C.2 Headroom limited



C.2a



C.2b

C.3 Width of passage or channel limited

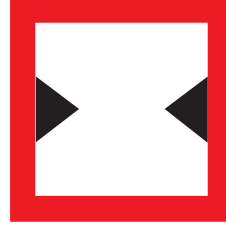

C.3a



C.3b

Note: Boards C.1, C.2 and C.3 may carry, in addition, figures indicating in metres the depth of water, the headroom and the width of passage or the channel respectively

C.4 There are restrictions on navigation: see the information plate below the sign

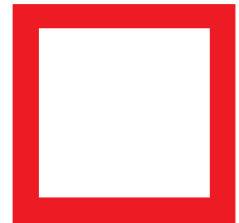

C.5 The channel lies at a distance from the right (left) bank; the figure shown on the sign indicates the distance in metres, measured from the sign, to which vessels should keep



D. RECOMMENDATORY SIGNS

D.1 Recommended opening

(a) In both directions
(see articles 6.25, 6.26 and 6.27)

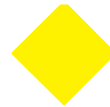

D.1a

or



D.1b

(b) Only in the direction indicated
(passage in the opposite direction prohibited)

(see articles 6.25, 6.26 and 6.27)

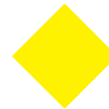
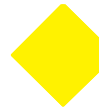

D.1c

or

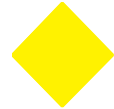
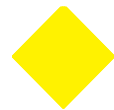

D.1d



D.1e

or



D.1f

D.2 You are recommended to keep within the area indicated (in openings of bridges or weirs)

(see article 6.24, para. 2 (b))

D.2a



or

D.2b



D.3 You are recommended to proceed:

D.3a In the direction shown by the arrow

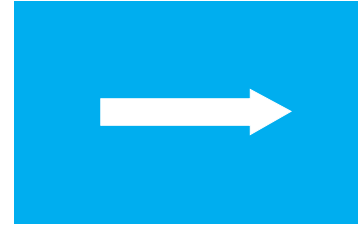

or

D.3b In the direction from the fixed light towards the isophase light



E. INFORMATIVE SIGNS

E.1 Entry permitted (general sign)

(see articles 6.08, 6.16, 6.26, 6.27 and 6.28 bis)

E.1a



or

E.1b, E.1c and E.1d



E.2 Overhead cable crossing

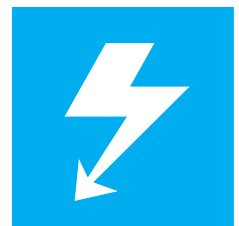

E.3 Weir

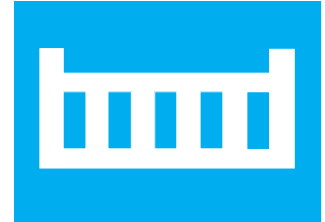

E.4

E.4a Ferry-boat not moving independently



E.4b Ferry-boat moving independently

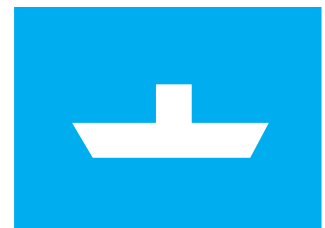

E.5 Berthing (i.e. anchoring or making fast to the bank) permitted on the side of the waterway on which the sign is placed

(see articles 7.02, para. 2 and 7.05, para. 1)



E.5.1 Berthing permitted on the stretch of water of the breadth measured from, and shown on the board in metres

(see article 7.05, para. 2)



- E.5.2 Berthing permitted on the stretch of water bounded by the two distances measured from, and shown on the board in metres

(see article 7.05, para. 3)



30-60

- E.5.3 Maximum number of vessels permitted to berth abreast on the side of the waterway on which the sign is placed

(see article 7.05, para. 4)



IV

- E.5.4 Berthing area reserved for pushing-navigation vessels that are not required to carry the marking prescribed in article 3.14 on the side of the waterway on which the sign is placed

(see article 7.06)



- E.5.5 Berthing area reserved for pushing-navigation vessels that are required to carry one blue light or one blue cone under article 3.14, paragraph 1, on the side of the waterway on which the sign is placed

(see article 7.06)



- E.5.6 Berthing area reserved for pushing-navigation vessels that are required to carry two blue lights or two blue cones under article 3.14, paragraph 2, on the side of the waterway on which the sign is placed

(see article 7.06)



E.5.7 Berthing area reserved for pushing-navigation vessels that are required to carry three blue lights or three blue cones under article 3.14, paragraph 3, on the side of the waterway on which the sign is placed
(see article 7.06)

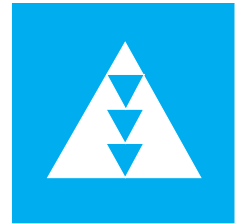

E.5.8 Berthing area reserved for vessels other than pushing-navigation vessels that are not required to carry the marking prescribed in article 3.14 on the side of the waterway on which the sign is placed
(see article 7.06)

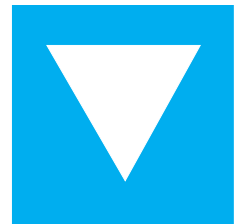

E.5.9 Berthing area reserved for vessels other than pushing-navigation vessels that are required to carry one blue light or one blue cone under article 3.14, paragraph 1, on the side of the waterway on which the sign is placed
(see article 7.06)



E.5.10 Berthing area reserved for vessels other than pushing-navigation vessels that are required to carry two blue lights or two blue cones under article 3.14, paragraph 2, on the side of the waterway on which the sign is placed
(see article 7.06)

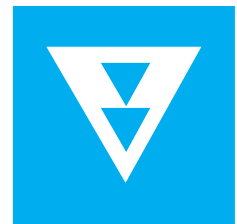

- E.5.11 Berthing area reserved for vessels other than pushing-navigation vessels that are required to carry three blue lights or three blue cones under article 3.14, paragraph 3, on the side of the waterway on which the sign is placed

(see article 7.06)

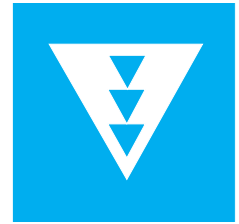

- E.5.12 Berthing area reserved for all vessels that are not required to carry the marking prescribed in article 3.14, on the side of the waterway on which the sign is placed

(see article 7.06)

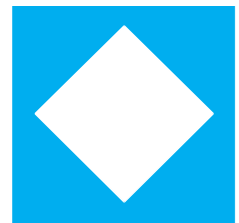

- E.5.13 Berthing area reserved for all vessels that are required to carry one blue light or one blue cone under article 3.14, paragraph 1, on the side of the waterway on which the sign is placed

(see article 7.06)

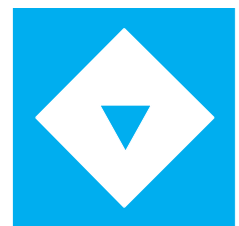

- E.5.14 Berthing area reserved for all vessels that are required to carry two blue lights or two blue cones under article 3.14, paragraph 2

(see article 7.06)

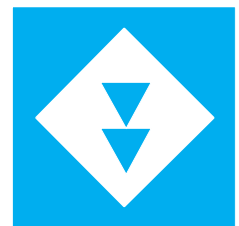

- E.5.15 Berthing area reserved for all vessels that are required to carry three blue lights or three blue cones under article 3.14, paragraph 3, on the side of the waterway on which the sign is placed

(see article 7.06)

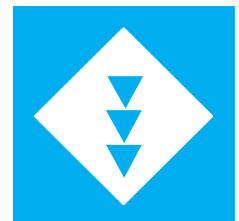

E.6 Anchoring (see article 7.03, para. 2) or trailing of anchors, cables or chains permitted on the side of the waterway on which the sign is placed (see article 6.18, para. 3)



E.6.1 Use of spuds permitted (see article 7.03)



E.7 Making fast to the bank permitted on the side of the waterway on which the sign is placed (see article 7.04, para. 2)

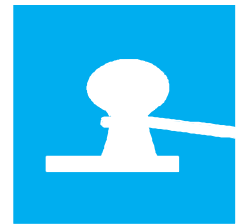

E.7.1 Berthing area reserved for loading and unloading vehicles. (Maximum duration of berthing permitted may be added on an information plate below the board)

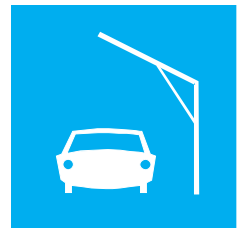

E.8 Turning area (see articles 6.13, para. 5 and 7.02 para. 1 (i))

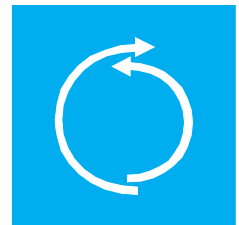

E.9 The waterways being approached are considered to be tributaries of this waterway (see article 6.16, para. 1)

E.9a

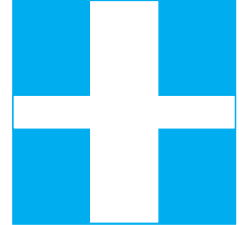

E.9b

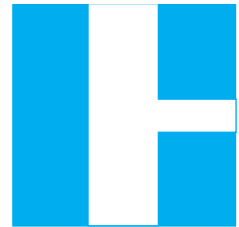

E.9c



E.10 This waterway is considered to be a tributary of the waterway being approached
(see article 6.16, para. 1)

E.10a

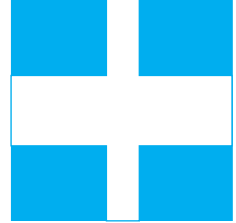

E.10b



E.11 End of a prohibition or obligation applying to traffic in one direction only, or end of a restriction

E.11a



or

E.11b



E.12 Advance signals: one or two white lights

(a) Fixed light(s): Difficulty ahead – stop if the regulations so require

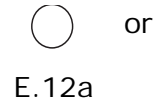

or



(b) Isophase light(s): You may proceed

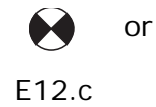

or



E.13 Drinking-water supply



E.14 Telephone



E.15 Motorized vessels permitted

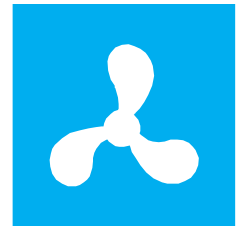

E.16 Sports or pleasure craft permitted⁵



E.17 Water skiing permitted



E.18 Sailing vessels permitted



E.19 Craft other than motorized vessels or sailing craft permitted



E.20 Use of sailboards permitted



⁵ The competent authorities may also use this board to permit small craft.

E.21 Zone authorized for high speed navigation of small sport and pleasure craft



E.22 Launching or beaching of small craft permitted



E.23 Possibility of obtaining nautical information by radio-telephone on the channel indicated



E.24 Water bikes permitted



E.25 Electrical power supply point

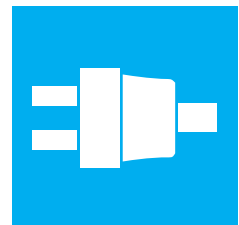

E.26 Winter harbour



E.26.1 Maximum number of vessels permitted to berth in winter harbour



E.27 Winter shelter

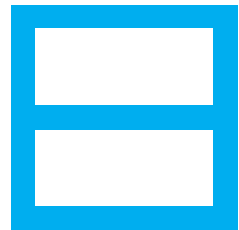

E.27.1 Maximum number of vessels permitted to berth in winter shelter

Maximum number of vessels permitted to berth abreast

Maximum number of rows of vessels which are berthed abreast



II. AUXILIARY SIGNS

The main signs (see section I) may be supplemented by the following auxiliary signs:

A. PANELS SHOWING THE DISTANCE AT WHICH THE REGULATION APPLIES OR THE SPECIAL FEATURE INDICATED BY THE MAIN SIGN IS TO BE FOUND

Note: The panels are placed above the main sign.

Examples:

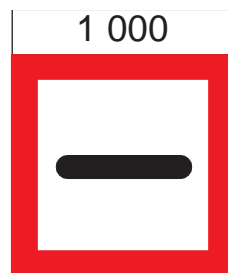

In 1,000 m, stop

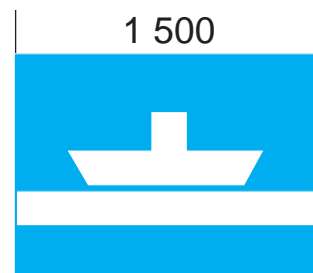

In 1,500 m, ferry-boat
not moving independently

B. ADDITIONAL LUMINOUS SIGNAL

Luminous white arrow combined with certain lights, with the following meanings:



(a) *With green light*

Example: Permission to enter the basin to which the arrow is pointing

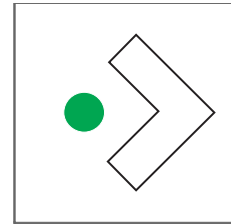

(b) *With red light*

Example: No entry to the basin to which the arrow is pointing

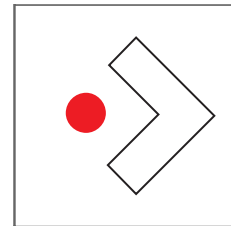

C. POINTERS SHOWING THE DIRECTION OF THE SECTION TO WHICH THE MAIN SIGN APPLIES

Note: The pointers need not necessarily be white and may be placed beside or below the main sign.

Examples:

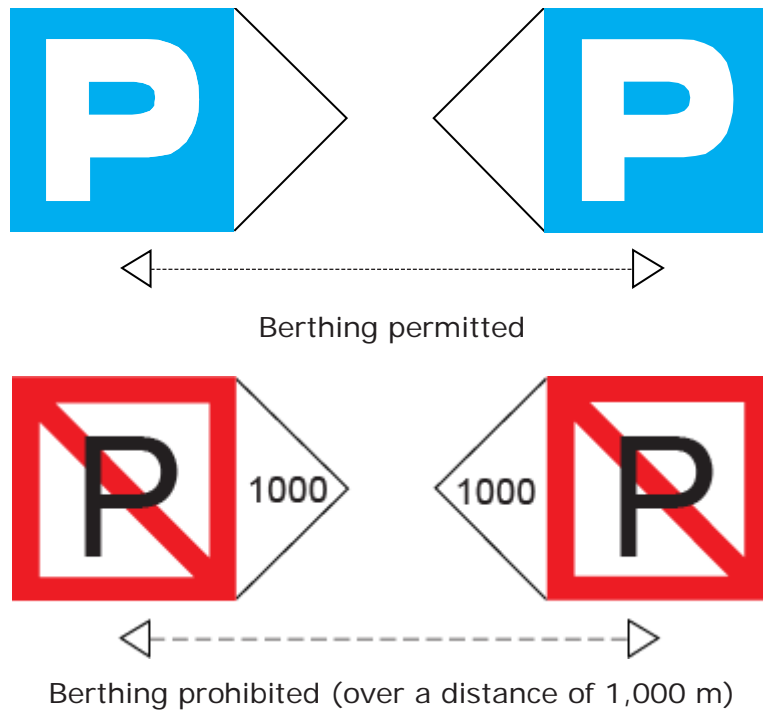

D. PANELS GIVING EXPLANATIONS OR ADDITIONAL INFORMATION

Note: These panels are placed below the main sign.

Examples:

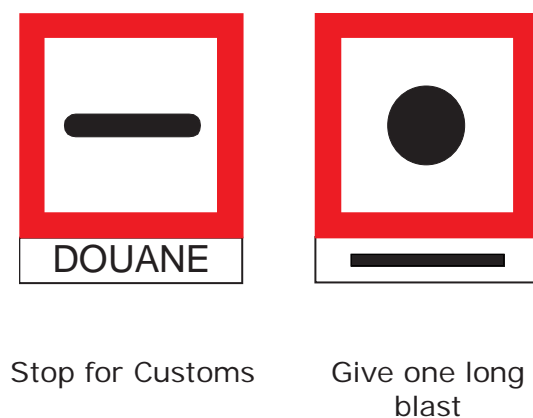

Annex 8

BUOYAGE AND MARKING OF THE WATERWAYS

I. GENERAL

A. MARKING OF WATERWAYS

The waterway, the fairway, as well as the danger points and obstacles are not always marked.

Floating waterway markings, are anchored at approximately 5 m distance from the limits that they indicate.

Groynes and shallows can be marked using fixed marks or buyos. These marks or buyos are usually placed on the borders of groynes and shallows or in front of them.

It is necessary to keep a sufficient distance from the marks and the buyos to avoid the risk of getting on the ground or hitting an obstacle.

B. DEFINITIONS

| | |
|-----------------|--|
| Light: | a distinctive light used as a marking. |
| Fixed light: | an uninterrupted light of constant intensity and colour. |
| Rhythmic light: | a light of constant intensity and colour operating in a characteristic and regularly repeated succession of spells of illumination and extinction. |

C. RHYTHM OF LIGHTS

Single-occulting light



Group-occulting light



Isophase light



Single-flashing light



Group-flashing light



Composite group-flashing light



Continuous scintillating light or continuous quick scintillating light



Group scintillating light or group quick scintillating light



6

⁶ In this instance, a long flash permits clear differentiation of the rhythm.

II. BUOYAGE OF FAIRWAY LIMITS IN THE WATERWAY

A. RIGHT-HAND SIDE OF THE FAIRWAY

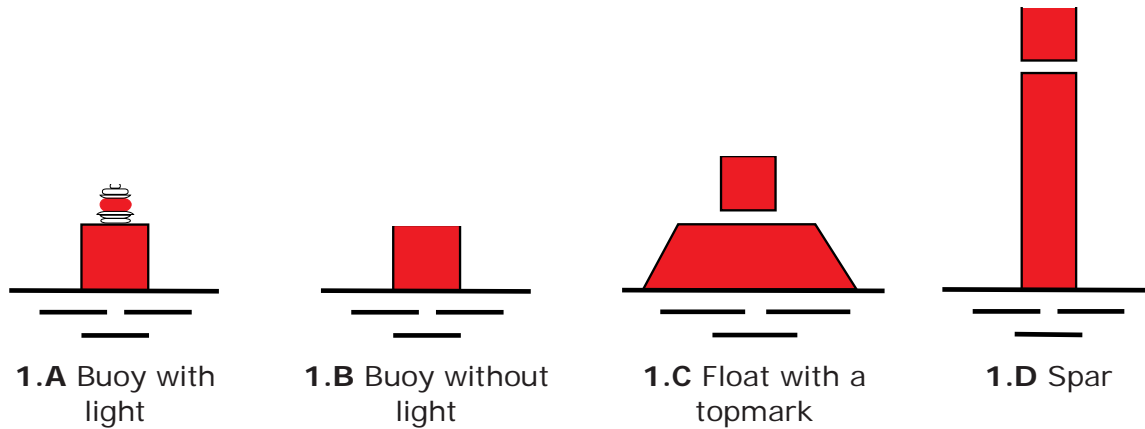

(fig. 1)

Colour: red

Form: cylindrical buoy or buoy with a topmark, or spar

Topmark (if any): red cylinder

Light (when fitted): rhythmic red light

Generally with radar reflector.

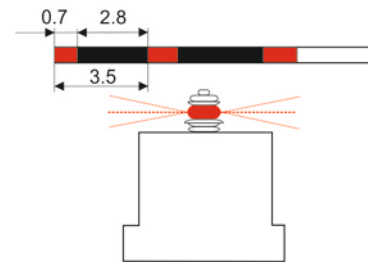

B. LEFT-HAND SIDE OF THE FAIRWAY

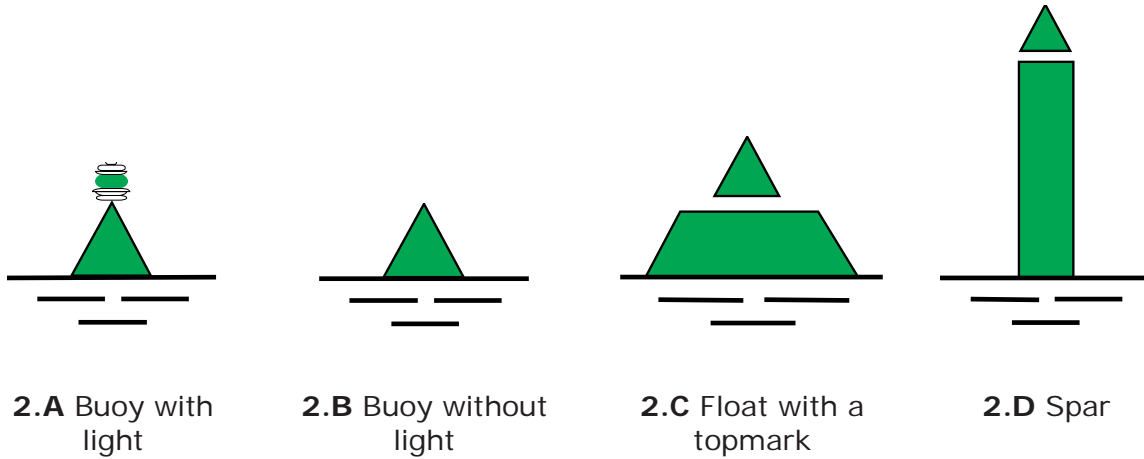

(fig. 2)

Colour: green

Form: conical buoy or buoy with a topmark, or spar

Topmark (if any): green cone, point upwards

Light (when fitted): rhythmic green light

Generally with radar reflector.

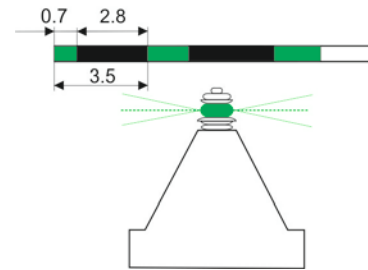

C. BIFURCATION OF THE FAIRWAY

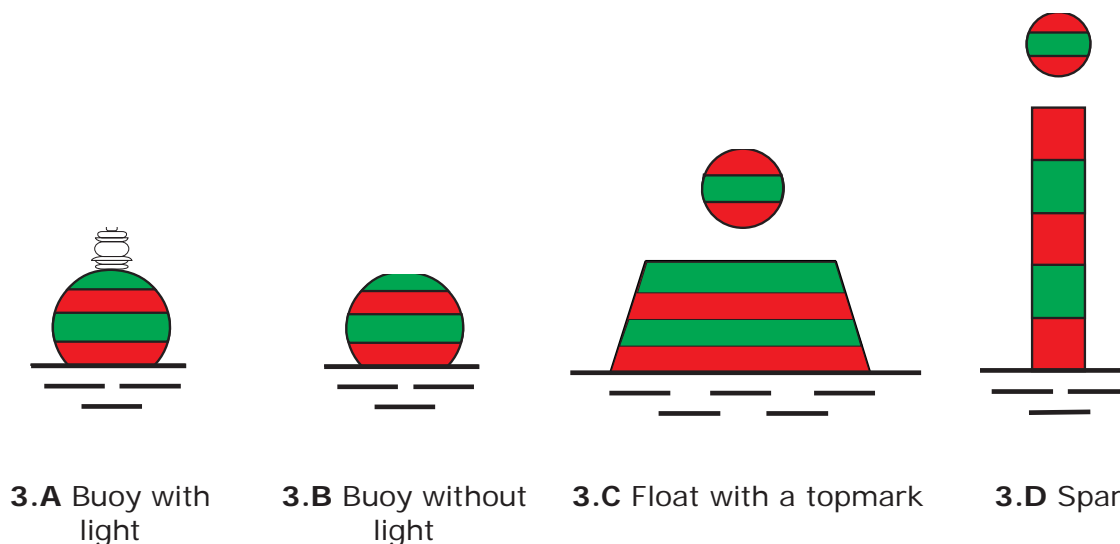

(fig. 3)

Colour: horizontal red and green bands

Form: spherical buoy or buoy with a topmark, or spar

Topmark (if any): sphere with horizontal red and green bands

Light (when fitted): continuous scintillating white light,

or isophase white light

(may be group-flashing white light with a group of three flashes)

Generally with radar reflector.

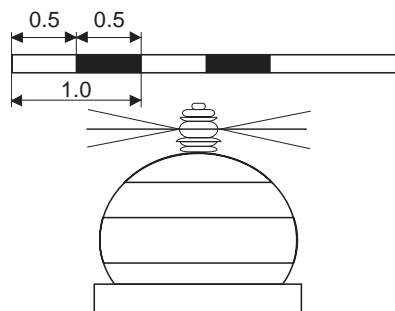

Where necessary, a red cylindrical topmark or green conical topmark placed above the bifurcation mark indicates on which side it is preferable to pass (main fairway).

The mark shall then bear a rhythmic red light or a rhythmic green light, as appropriate.

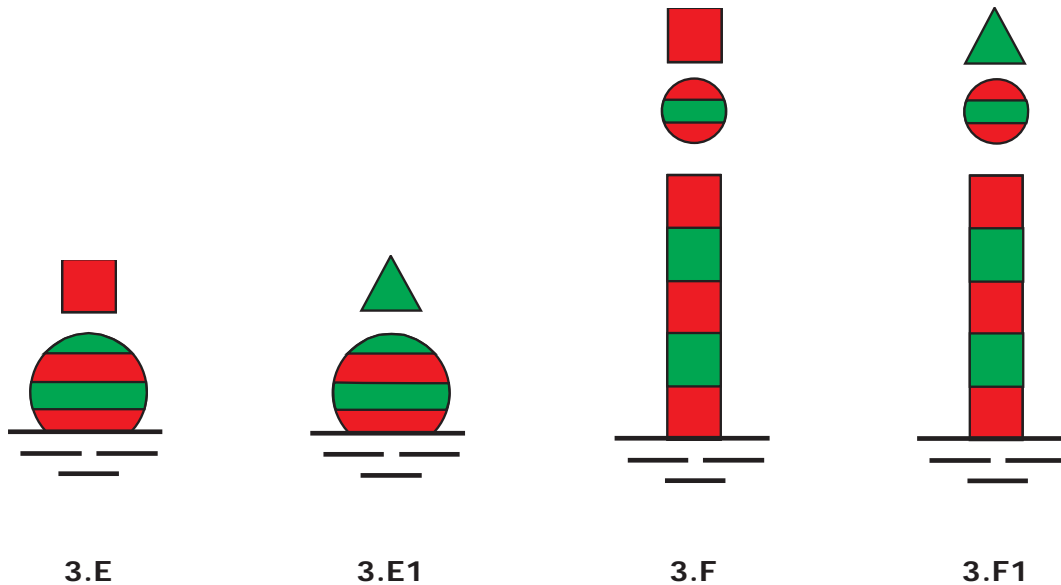

(fig. 4)

A letter "P" painted in white on the buoys described in paragraphs 1 and 2 indicates that the fairway is adjacent to a berthing area. If the buoys showing the letter "P" carry a light, its rhythm shall be different from that of the lights of other buoys placed along the fairway limit.

III. MARKS ON LAND INDICATING THE POSITION OF THE FAIRWAY

A. MARKS ON LAND INDICATING THE POSITION OF THE FAIRWAY IN RELATION TO THE BANKS

These marks indicate the position of the fairway in relation to the bank and, together with the buoyage of the waterway, mark the fairway at points where it approaches a bank; they also serve as landmarks.

1. Channel near the right bank

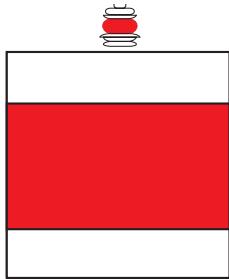

4.A With light

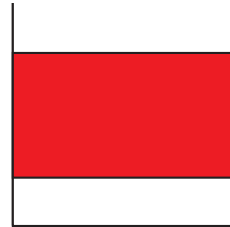

4.B Without light

(fig. 5)

Colour: red/white

Form: post with topmark

Topmark: square boards (sides horizontal and vertical), red, with two horizontal white stripes

Light (when fitted): rhythmic red light.

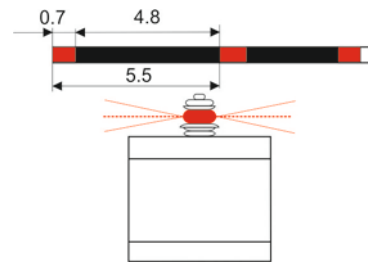

2. Channel near the left bank

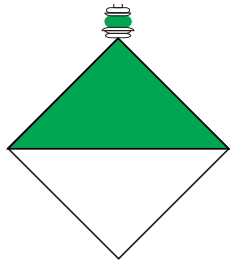

5.A With light

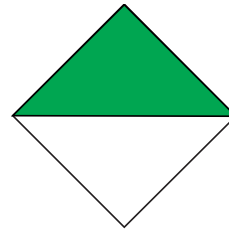

5.B Without light

(fig. 6)

Colour: green/white

Form: post with topmark

Topmarks: square board (diagonals horizontal and vertical),

upper half painted green and lower half white

Light (when fitted): rhythmic green light.

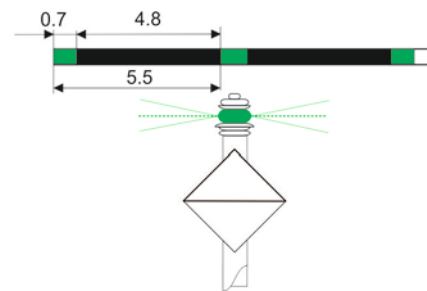

3. Use of marks

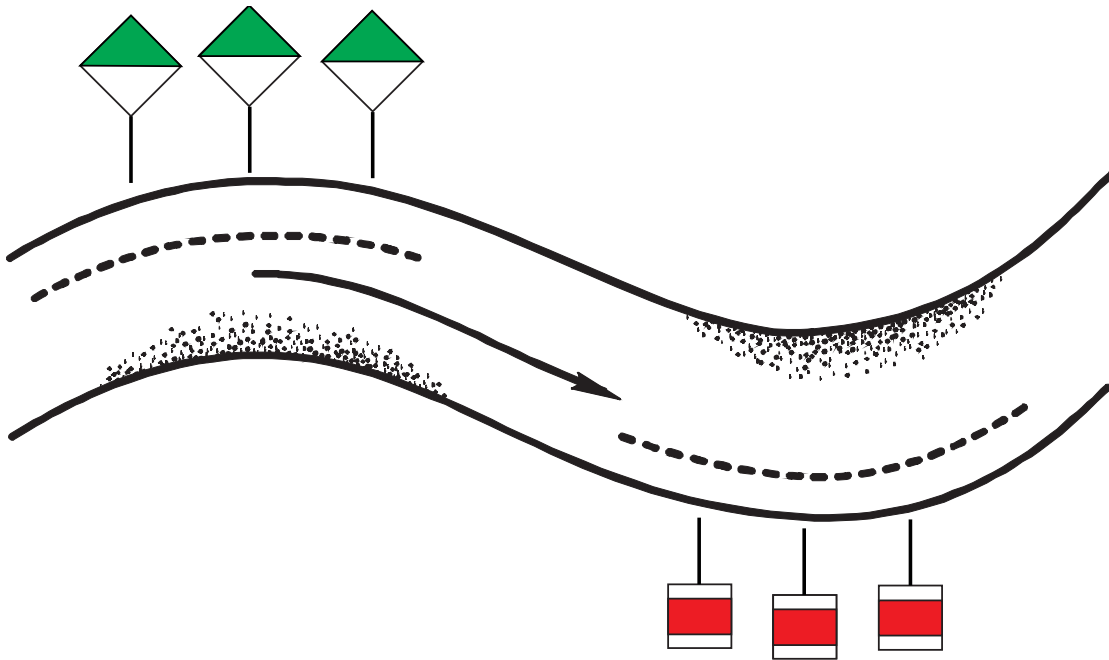

(fig. 7)

B. MARKING OF CROSS-OVERS

These marks indicate at what point the fairway passes from one bank to another and also give the axis of this cross-over.

1. Right bank

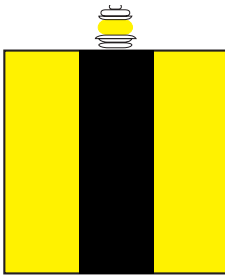

4.C With light

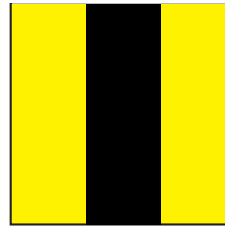

4.D Without light

(fig. 8)

Colour: yellow/black

Form: post with topmark

Topmarks: square yellow board (sides horizontal and vertical), with a central vertical black stripe

Light (when fitted): yellow light, flashing or occulting, with an even-number characteristic other than the group-flashing rhythm with a group of two flashes.

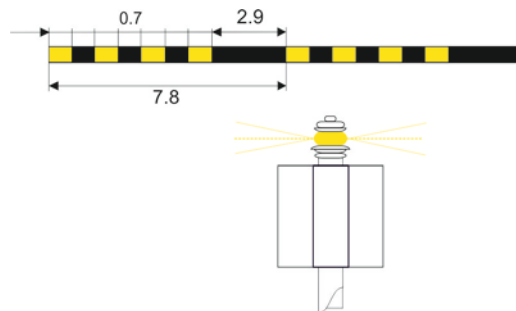

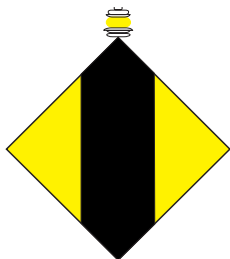
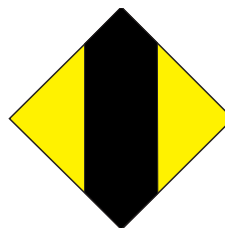
2. Left bank**5.C With light****5.D Without light**

(fig. 9)

Colour: yellow/black

Form: post with topmark

Topmark: square yellow board (diagonals horizontal and vertical), with a central vertical black stripe

Light (when fitted): yellow light, flashing or occulting, with an odd-number characteristic other than the group-flashing rhythm with a group of three flashes.

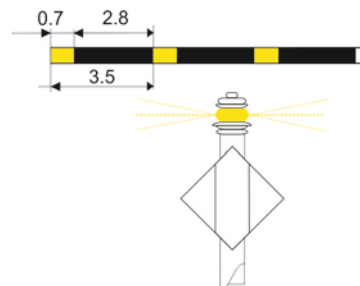

3. Use of marks

3.1 Mere indication of cross-over

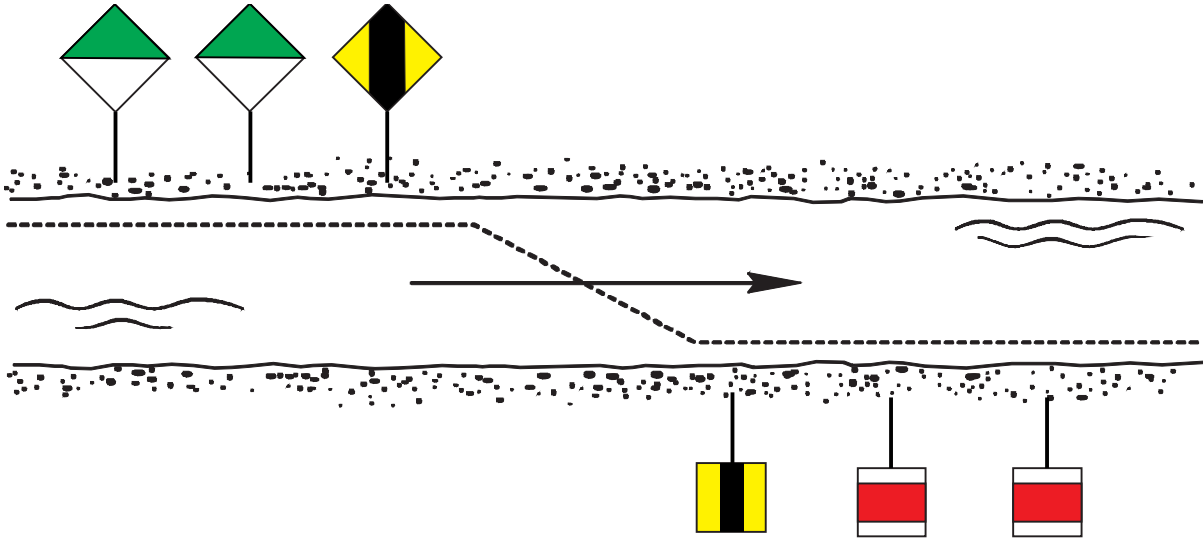

(fig.10)

3.2 Indication of the axis of a long cross-over

Two identical signs placed one behind the other on the same bank, the first sign positioned lower than the second one, forming an alignment marking the axis of a long cross-over.

Lights (if any): yellow (the forward light and rearward light generally having the same rhythm; however, the rearward light may be a fixed light).

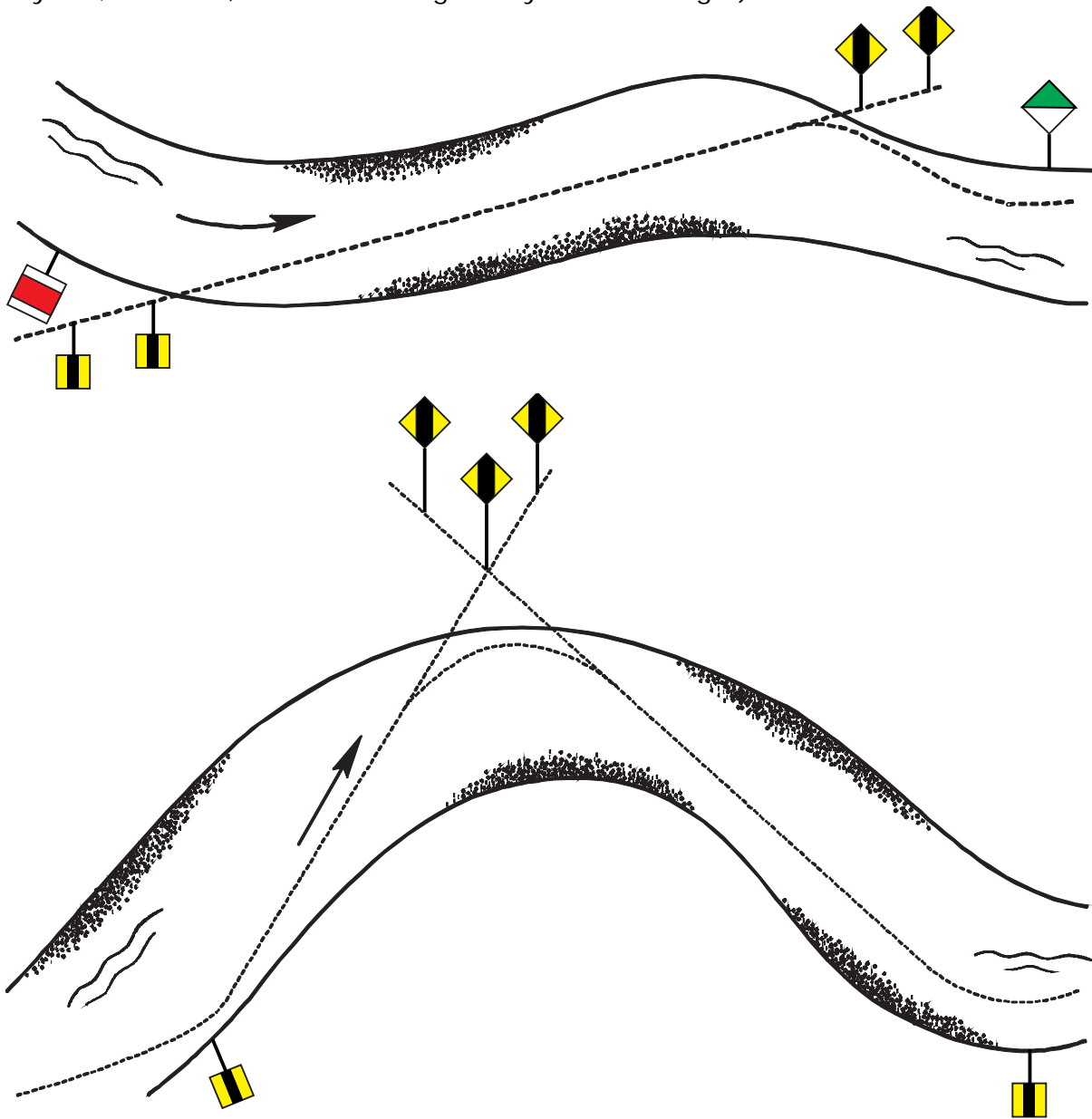

(fig.11)

IV. BUOYAGE AND MARKING OF DANGER POINTS AND OBSTACLES

A. FIXED MARKS

1. Right-hand side

Colour: red

Form: post with topmark

Topmark: red cone, point downwards

Light (when fitted): rhythmic red light.

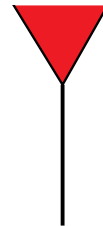

4.F

(fig. 12)

2. Left-hand side

Colour: green

Form: post with topmark

Topmark: green cone, point upwards

Light (when fitted): rhythmic green light.

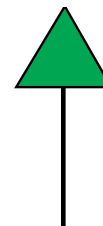

5.F

(fig. 13)

3. Bifurcation

Colour: red/green

Form: post with topmark

Topmark: red cone, point downwards,
above a green cone, point
upwardsLight (when fitted): continuous
scintillating white
light or isophase
white light (may
be the group-
flashing white light
a group of three
flashes)

Period

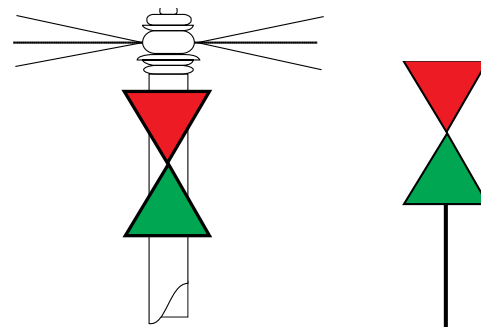
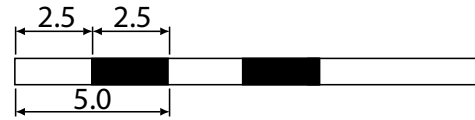

6.A

6.B

(fig. 14)

The above cones may be replaced by triangular panels with a white background and a red or green border.

4. Secondary arms of the waterway, mouths of waterways and entrances to harbours

On the approach to secondary arms of the waterway, to mouths of waterways and to harbour entrances, the bank walls on both sides of the waterway may be marked as far as the head of the dividing mole by the fixed marks described in 1 and 2 above, figures 12 and 13. Vessels entering the harbour are regarded as upstream traffic.

B. BUOYS

1. Right-hand side

Colour: horizontal red and white bands

Form: spar-buoy or spar

Topmark: red cylinder

Light (when fitted): rhythmic red light

Generally with radar reflector.

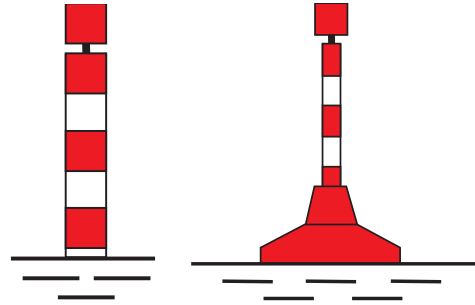

1.F1

1.F

(fig. 15)

2. Left-hand side

Colour: horizontal green and white bands

Form: spar-buoy or spar

Topmark: green cone, point upwards

Light (when fitted): rhythmic green light

Generally with radar reflector.

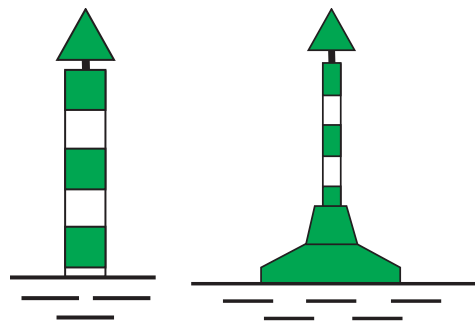

2.F1

2.F

(fig. 16)

Example of use of the buoyage and marking described in chapters II and IV

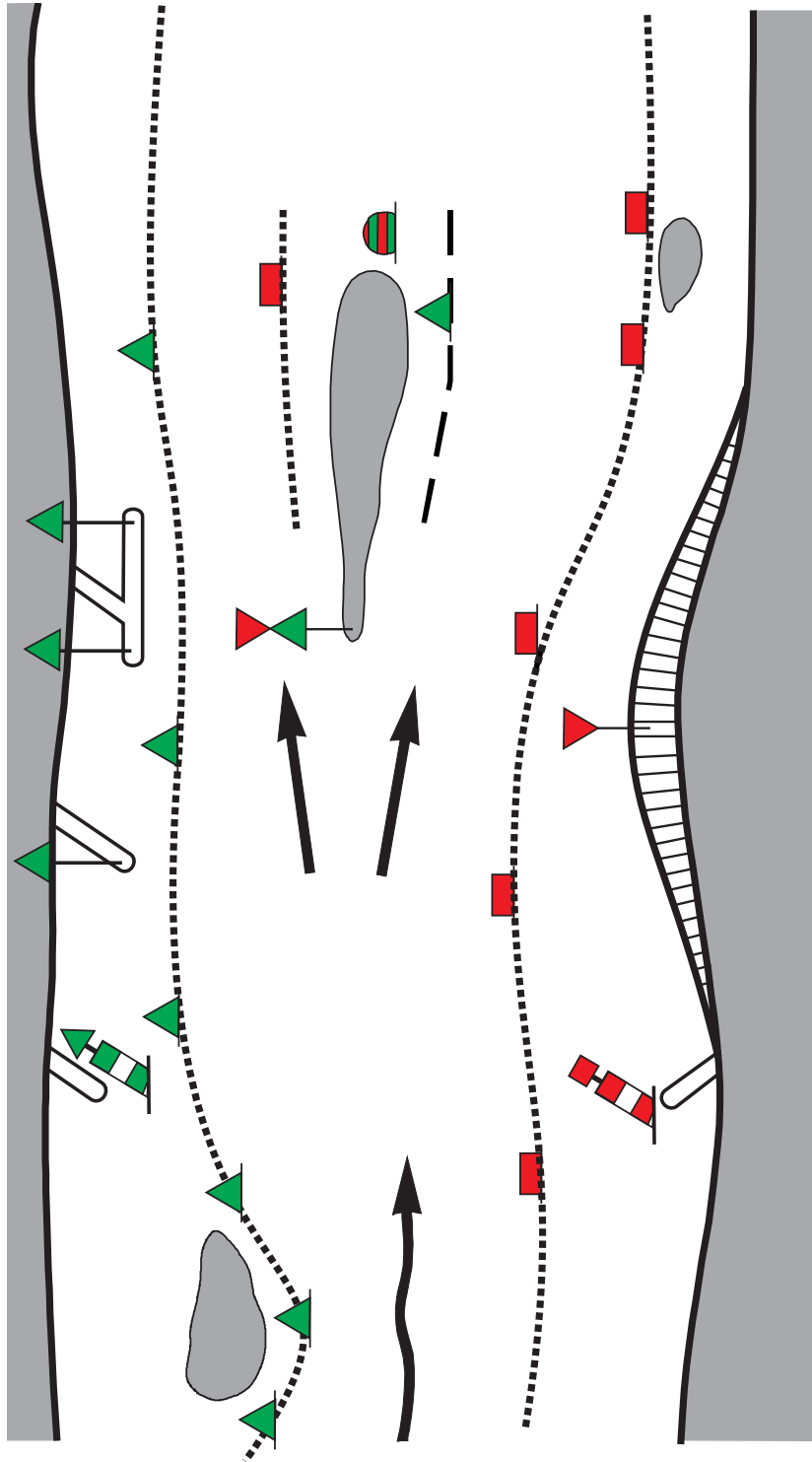

(fig. 17)

IV BIS. OTHER MARKING OF DANGER POINTS AND OBSTACLES IN THE WATERWAY

A. PASSAGE PERMITTED ON THE CLEAR SIDE WITHOUT REDUCING SPEED

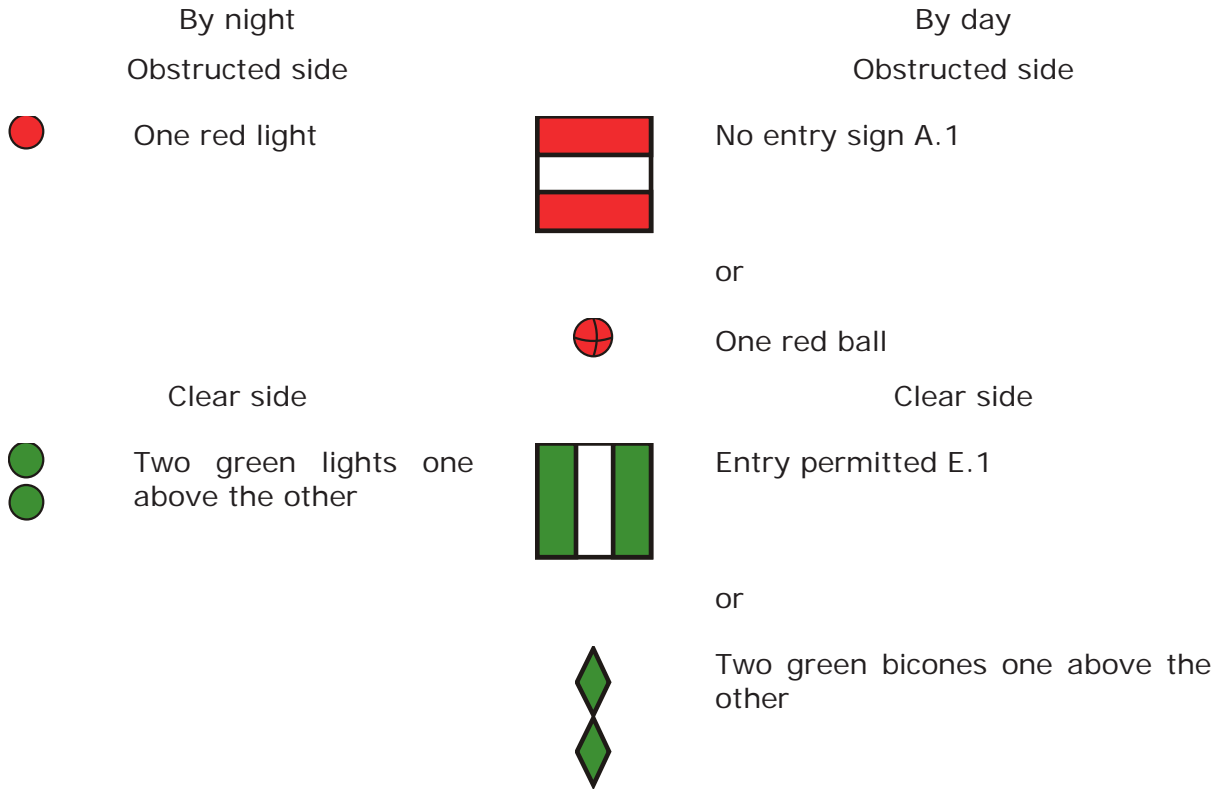

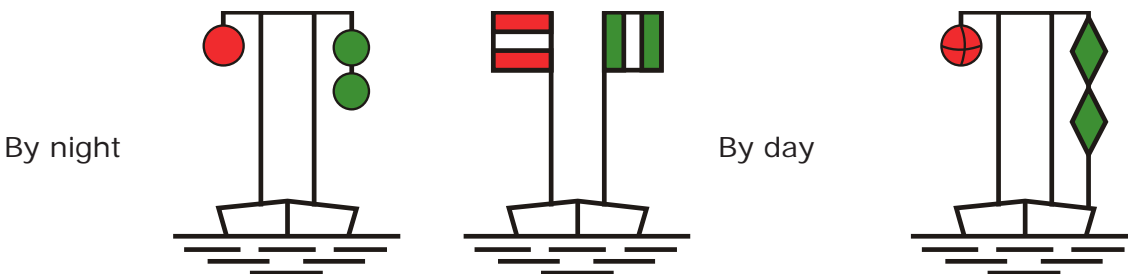

(fig. 17 bis)

Example:



(fig. 17 ter)

B. PASSAGE PERMITTED ON THE CLEAR SIDE AT REDUCED SPEED (AVOID CREATING WASH)

| | | | |
|--------|-------------------------------------|---|---|
| | By night | | By day |
| | Obstructed side | | Obstructed side |
| ● | One red light |  | One red flag or red board |
| | Clear side | | Clear side |
| ● ○ | One red light above one white light |  | One red flag or board above one white flag or board |

(fig. 17 quater)

Example:

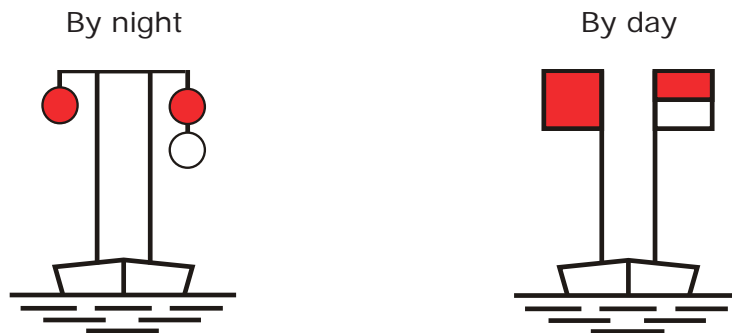

(fig. 17 quinquies)

V. ADDITIONAL MARKING FOR NAVIGATION BY RADAR

A. MARKING OF BRIDGE PIERS (WHERE APPLICABLE)

1. Yellow floats with radar reflector (placed upstream and downstream from piers)

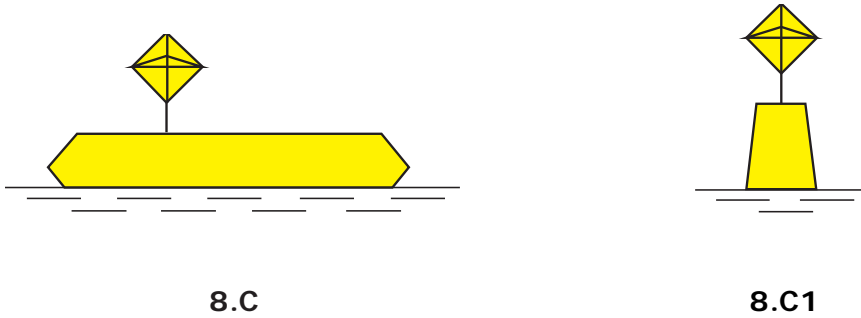

(fig. 18)

2. Pole with radar reflector placed upstream and downstream from bridge piers

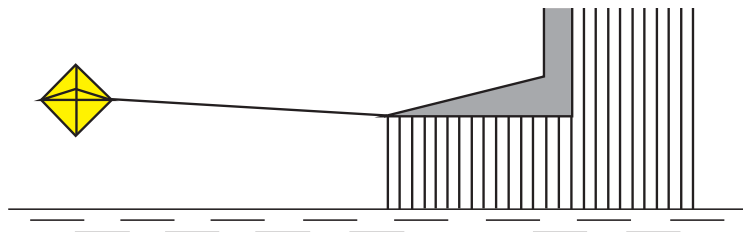

8.C2

(fig. 19)

B. MARKING OF OVERHEAD CABLES (WHERE APPLICABLE)

1. Radar reflectors secured to the overhead cable (giving a radar image of a series of points to identify the overhead cable)

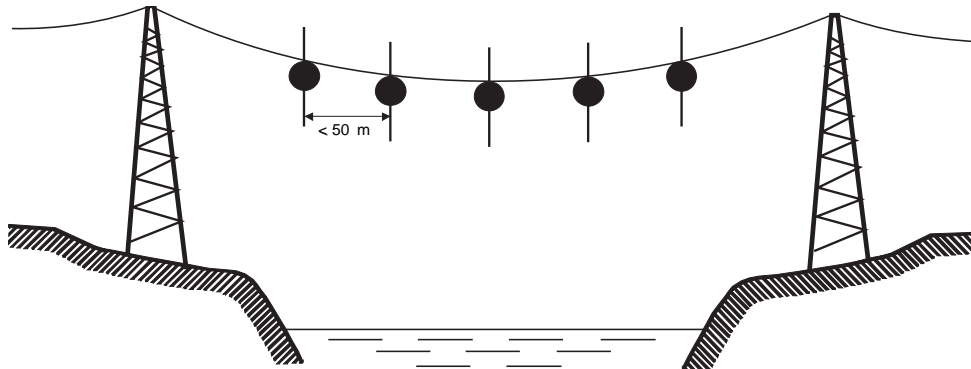
**8.C3**

(fig. 20)

2. Radar reflectors placed on yellow floats arranged in pairs near each bank (each pair giving a radar image of two points side by side to identify the overhead cable)

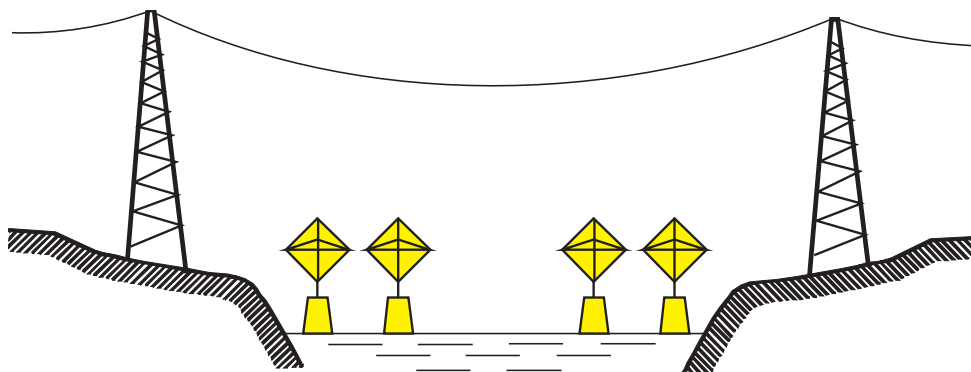
**8.C4**

(fig. 21)

VI. ADDITIONAL BUOYAGE AND MARKING OF LAKES AND BROAD WATERWAYS

A. MARKING OF DANGER POINTS, OBSTACLES AND SPECIAL FEATURES

1. Cardinal marks

Definition of cardinal quadrants and marks

The four quadrants (North, East, South and West) are bounded by the true bearings NW NE, NE-SE, SE-SW, SW-NW taken from the point of interest.

A cardinal mark is named after the quadrant in which it is placed.

The name of a cardinal mark indicates that the mark should be passed on the side of the quadrant named.

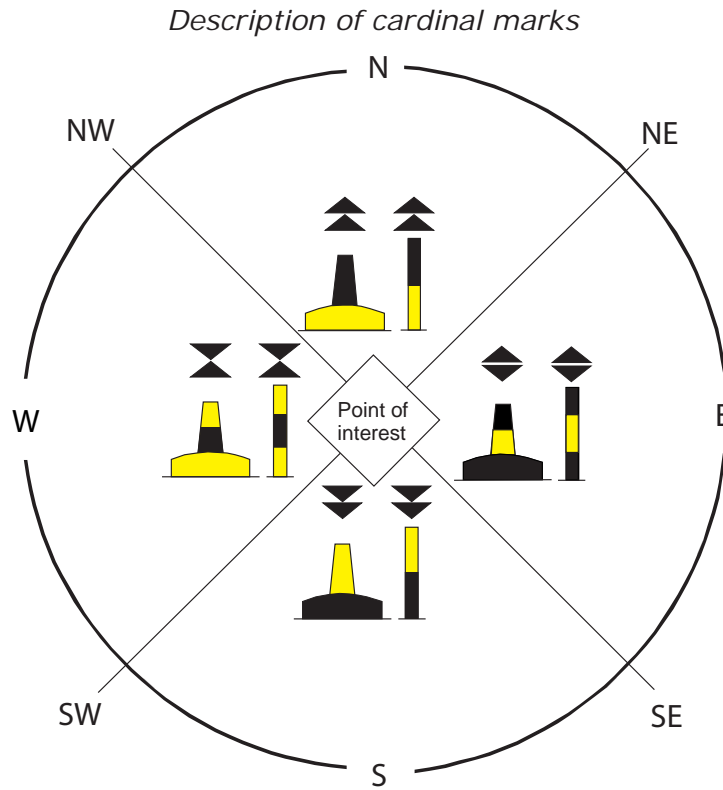

(fig.22)

North cardinal mark

Colour: black above yellow
 Form: pillar or spar, with topmark
 Topmark: two black cones, one above the other, points upward

Light (when fitted):

Colour: white
 Rhythm: continuous quick
 scintillating or
 continuous scintillating.

East cardinal mark

Colour: black with a single broad horizontal yellow band
 Form: pillar or spar, with topmark
 Topmark: two black cones, one above the other, base to base

Light (when fitted):

Colour: white
 Rhythm: group quick scintillating
 or group scintillating,
 with a group of three
 flashes.

South cardinal mark

Colour: yellow above black
 Form: pillar or spar, with topmark
 Topmark: two black cones, one above the other, points downward
 Light (when fitted) :

Colour: white
 Rhythm: group quick
 scintillating or group
 scintillating, with a
 group of six flashes
 followed by a long
 flash of not less than
 two seconds duration.

West cardinal mark

Colour: yellow with a single broad horizontal black band
 Form: pillar or spar, with topmark
 Topmark: two black cones, one above the other, point to point

Light (when fitted):
 Colour: white
 Rhythm: group quick
 scintillating or group
 scintillating, with a
 group of nine flashes.

2. Isolated danger marks

An isolated danger mark is a mark erected on, or moored above an isolated danger which has safe water all around it.

Colour: black with one or more broad horizontal
 Form: any (generally pillar or spar) with topmark
 Topmark: two black spheres, one above the other
 Light (when fitted):
 Colour: white
 Rhythm: group flashing (group of two flashes)

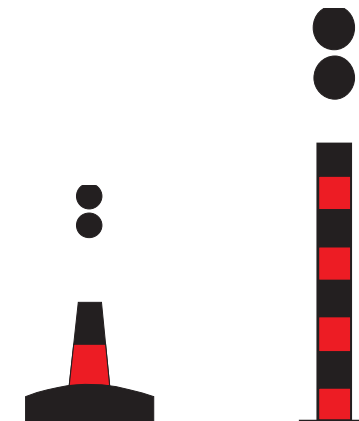

8.D

8.D1

(fig. 23)

B. MARKING OF THE AXIS OF A CHANNEL, THE MIDDLE OF A CHANNEL OR A LANDFALL

Safe-water marks

- Colour: red and white vertical stripes
- Form: spherical buoy or pillar or spar with topmark
- Topmark (if any): single red sphere
- Light (when fitted):
- Colour: white
- Rhythm: isophase, single-occluding, one long flash every 10 seconds or Morse code "A"

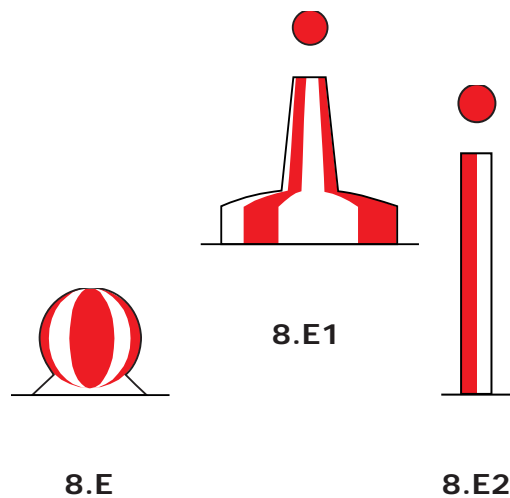

(fig. 24)

C. WEATHER SIGNS AND SIGNALS ON LAKES

"Caution" warning

A yellow light producing about 40 flashes per minute constitutes a "caution" warning.

The "caution" warning indicates the probable onset of a dangerous phenomenon without specifying the time thereof.

"Danger" warning

A yellow light producing about 90 flashes per minute constitutes a "danger" warning.

The danger warning indicates the imminent arrival of a dangerous phenomenon.

VII. MARKING OF PROHIBITED OR RESTRICTED AREAS

1. Special marks

| | |
|----------------------|--|
| Colour: | yellow |
| Form: | any, but different from navigational marks |
| Topmark (if any): | single yellow "X" shape |
| Light (when fitted): | |
| Colour: | yellow |
| Rhythm: | any, other than those described in chapter VI. |

2. The nature of the prohibition or restriction shall, insofar as possible, be made clear in writing (for instance, in charts) and by local information.

Local information may be carried on yellow buoys. It may also be given by means of topmarks placed on such buoys in lieu of a topmark as prescribed above. For example, buoys at the edge of a zone where navigation is totally prohibited may carry a staff with a rigid, triangular red pennon.

Information may be given on boards placed on the bank and representing any of the prohibitory or informative signs prescribed in annex 7, sections I.A and I.E. Such boards may, if necessary, be supplemented by an arrow indicating the direction of the area to which the sign applies (see annex 7, section II.3).

3. If a shore zone in which one or more types of vessel or activity are prohibited or restricted is crossed by a fairway in which one such type of vessel or activity is not prohibited or restricted (except as regards an entrance to a harbour to which section II applies), the sides of that fairway may, again, be marked by yellow buoys. The upper parts of the two buoys at the entrance may, if necessary, be painted red on the right-hand side and green on the left-hand side for a boatmaster leaving the fairway.

On the bank, boards as prescribed in annex 7, E.15 to E.20, may indicate the type of craft or activity permitted (e.g. the "water skiing" permission sign to indicate a water-skiing fairway across an area where all navigation, or only water skiing, is prohibited); the markings may be supplemented by the arrow prescribed in annex 7, section II.3.

Where a zone open for more than one activity is crossed by a fairway in which only one activity is permitted, the sides of that fairway may be marked as in the above case. A board on the bank may indicate the activity permitted.

VIII. BUOYS FOR MISCELLANEOUS PURPOSES

If buoys are required for purposes other than those referred to above, they shall be predominantly white. They may carry pictograms.

IX. ENTRANCES TO HARBOURS

1. Marking of the entrance

By day:

To port of a vessel entering: red device, generally cylindrical; or a post with a cylindrical red topmark; or a red rectangle painted in the jetty;

To starboard of a vessel entering: green device, generally conical; or a post with a conical green topmark; or a green triangle, point upward, painted on the jetty.

At night:

The day markings described above may be illuminated.

If lights are used:

To port of a vessel entering: a red light, generally rhythmic;

To starboard of a vessel entering: a green light, generally rhythmic.

In certain cases, only one of these lights may be used.

2. This marking may be also used for entrances to tributary waterways, entrances to secondary arms of waterways and entrances to docks.

The following sketch illustrates the provisions of chapters VI, VII and IX.

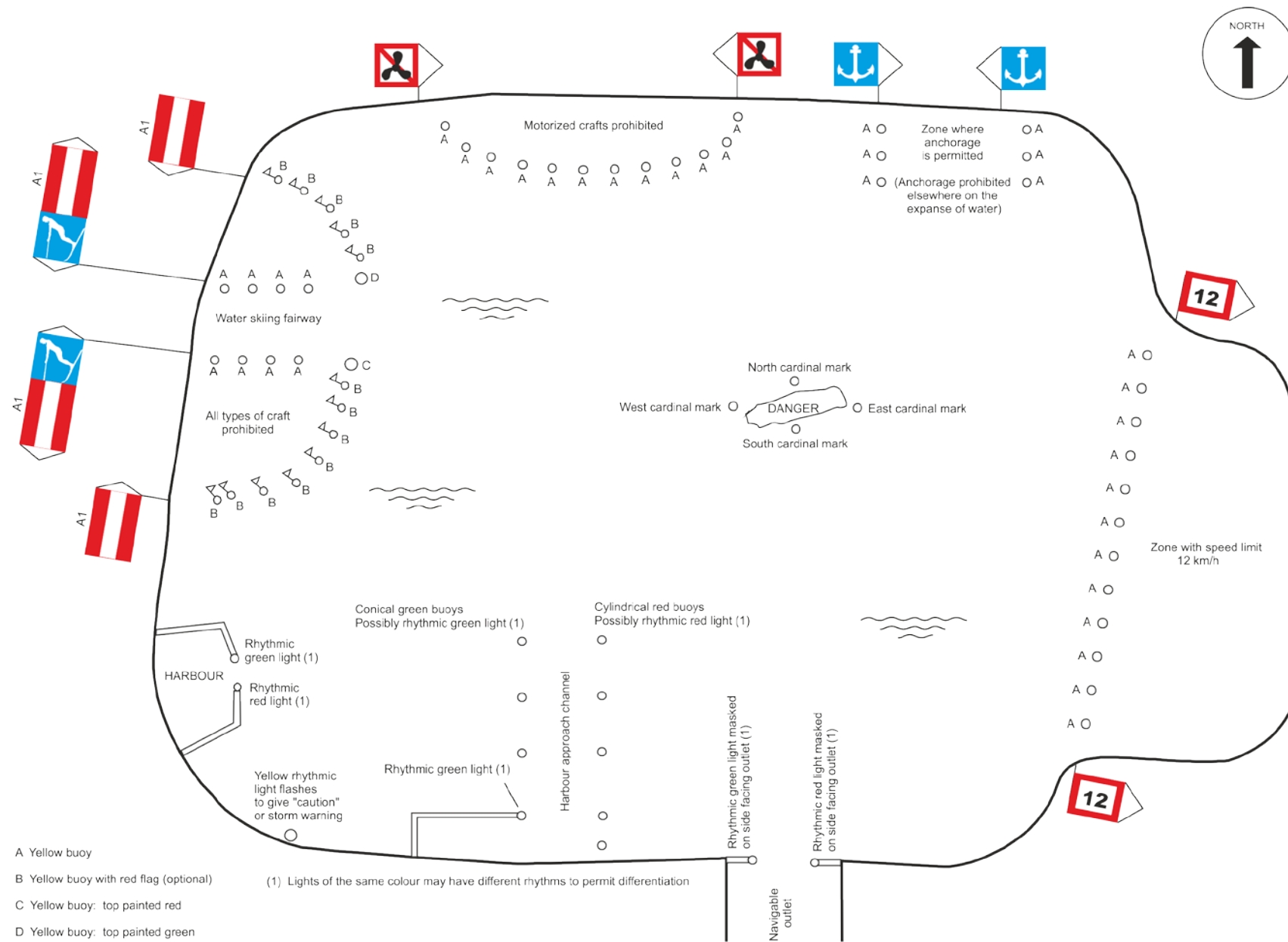

(fig.25)

Annex 9 MODEL USED-OIL LOG

Page 1

Order No:

| | |
|--|----------------|
| Type of vessel | Name of vessel |
| Unique European Vessel Identification Number or official number: | |
| Place of issue: | |
| Date of issue: | |

This log contains pages

Seal and signature of the authority issuing the log

.....

Page 2

Issuance of used-oil logs

The first used-oil log, carrying order number 1 on page 1, shall be issued by a competent authority on presentation of a valid inspection certificate or another certificate recognized as its equivalent. This authority shall also enter the required particulars on page 1.

All subsequent logs, which are to be numbered sequentially, shall be by a competent authority. However, they shall be issued only upon presentation of the previous log. The previous log shall be stamped indelibly with the words "Not valid". Following its renewal, the previous log shall be kept on board for at least six months from the date of the last entry.

Page 3 and following

1. Accepted oily and greasy wastes accepted generated from the operation of the vessel:

1.1 Used oil: _____ l

1.2 Bilge water from:

Aft engine room _____ l

Fore engine room _____ l

Other premises _____ l

1.3 Other oily and greasy wastes:

Used rags _____ kg

Waste grease _____ kg

Used filters _____ units

Receptacles _____ units

2. Notes:

2.1 Unaccepted waste: _____

2.2 Other comments: _____

Place: _____

Date: _____

Seal and signature of the reception facility

**Annex 10
GENERAL TECHNICAL SPECIFICATIONS
APPLICABLE TO RADAR EQUIPMENT**

(Left void)⁷

⁷ Requirements applicable to radar equipment shall be included in “Recommendations on Harmonized Europe-Wide Technical Requirements for Inland Navigation Vessels” (Resolution No. 61).

Annex 11 SAFETY CHECKLIST FOR BUNKERING FUEL

Number: Year:

| | |
|---|---|
| Bunker boat / Bunker station / Tank truck | Bunkering Vessel |
| Name: | Name: |
| Unique European Vessel identification number / Official number: | Unique European Vessel identification number / Official number: |
| Boatmaster: | Boatmaster: |
| Bunkering attendant: | Responsible person for the bunkering procedure (bunker watch): |

| | Filler necks | | | Total |
|--|--------------|---|---|-------|
| | 1 | 2 | 3 | |
| Position of filler neck (e.g. port side aft; bow thruster tank; ...) | | | | |
| Tank capacity of the tanks to be filled via the respective filler neck: | | | | |
| Tank content before beginning of the bunkering according to reading of tank level: | | | | |
| Free capacity of the tanks immediately after the filler neck: | | | | |
| Agreed takeover quantity: | | | | |

General:

- The mooring between the bunkering vessel and the bunker boat / bunkering station is correct and has been checked.
- The lighting is sufficient to supervise the bunkering procedure.
- Communication between bunker attendant and bunker watch is ensured.
- The hose lines are not subject to tensile forces nor to torsion; the minimum bending radii are respected.

Bunkering procedure

 with without overfill protection
(automatic stopping device)**In case of use of a fuelling hose with flange or quick coupling:**

- The connection of the fuelling hose with the filler neck has been checked and is in good working condition.

In case of use of a fuelling hose with nozzle:

- The bunker watch is familiar with the operation of the nozzle and is capable to activate an emergency stop.
- The nozzle reaches deep enough into the filler neck and has been secured in its position.

Date:

Place (River-km respectively berth number):

Beginning of bunkering procedure (Time):

Bunkering attendant:

Bunker watch:

.....

.....

Signature

Signature

End of bunkering procedure (Time):
